

ST6 Series DIGITAL POCKET MANOMETER **dpm**

OPERATING MANUAL



CONTENTS



Limitations of Use	01
Keypad Controls	02
Mode of Operation	03
Pressure Mode Display	04
Velocity Mode Display	05
Live Volume Display	06
Volume Mode Display	07
Temperature Mode Display	08
Pressure Connections	09
Velocity	10
Volume Flow Rates	11
User Menu	12 - 17
Option Menu	18 - 21
Conversion Tables	22
Duct Traverse Points	23
Downloading Data	24
Maintenance and Calibration	24
Specifications	25 - 26

ST6 Series instruments are intended for measurement of low differential air pressure in and around commercial and industrial air handling systems and for use with a Pitot Static Tube, dpm Ane™ head, dpm Hood and dpm Short Hood.

The instruments are not suitable for liquid pressure measurement and must not be used with corrosive, toxic or otherwise hazardous gases.

The instruments are not classified as “Flameproof” or “Intrinsically Safe” and consequently must not be used where an explosion hazard may exist. They are also not authorised for Life Support applications.

During normal operation small quantities of air (typically less than 0.1ml/min) may pass into or out of the system under test and it is the responsibility of the user to consider the consequences of such leakage before determining the suitability of the instrument for any particular purpose.

The instrument must be turned off before it is stored or transported and, if it is to be stored for a long period of time or is to be transported by air, the batteries must be removed.

There is a 12-month guarantee on all manufactured parts.

This guarantee does not cover any consumables, and/or wear and tear during normal or abnormal use.

The guarantee becomes null and void if the instruments parts have been tampered with, misused, abused or used outside the parameters set out in this manual.

The manufacturer will determine if the instrument is repairable or requires replacement; charges may apply.

NOTE: RECHARGEABLE INSTRUMENTS MUST NOT BE FITTED WITH DRY CELL BATTERIES AS THIS MAY CAUSE A MALFUNCTION.

KEYPAD CONTROLS



On and Off.



Operate backlight.



Scroll up in menu modes.

Increase digits.

Toggle between displays in mode of operation.

(model dependent) The displays are arranged in loop formation as follows:

▲ **Pressure Mode:**

Pressure
Temperature

▲ **Velocity Mode:**

Velocity
Temperature
Live Volume

▲ **Volume Mode:**

Volume
Temperature



Scroll to the right in menu modes.

Toggle between units of measurement in mode of operation.

(model dependent) The units are arranged in loop formation as follows:

Pa ► KPa ► mbar ► mmH₂O ► inH₂O ► mmHg ► inHg ► PSI ► m/sec ► ft/min ► L/sec ► m³/sec ► m³/hr ► cfm ► Pa



Scroll down in menu modes.

Decrease digits.

Toggle between displays in mode of operation.

(model dependent) The displays are arranged in loop formation as follows:

▼ **Pressure Mode:**

Pressure
Temperature

▼ **Velocity Mode:**

Velocity
Live Volume
Temperature

▼ **Volume Mode:**

Volume
Temperature



Scroll to the left in menu modes.

Toggle between units of measurement in mode of operation.

(model dependent) The units are arranged in loop formation as follows:

Pa ◀ cfm ◀ m³/hr ◀ m³/sec ◀ L/sec ◀ ft/min ◀ m/sec ◀ PSI ◀ inHg ◀ mmHg ◀ inH₂O ◀ mmH₂O ◀ mbar ◀ KPa ◀ Pa



Used in conjunction with the  key to access the User Menu.

Access the option menu.

Accept commands in the menu modes.

zero

Overrides the time period of the Auto Zero system.

To change this timing see User Menu page 13.

units

Toggle between units in the measurement mode.

(model dependent) The units are arranged in loop formations as follows:

Pa → KPa → mbar → mmH₂O → inH₂O → mmHg → inHg → PSI → m/sec → ft/min → L/sec → m³/sec → m³/hr → cfm → Pa

Being an auto ranging instrument, the correct resolution and the decimal point will be displayed according to the pressure being applied.

speed

Smooths out the response to applied pressure changes. Time constant:

F = 0 sec S1 = 5 sec S2 = 10 sec S3 = 15 sec S4 = 20 sec

store

Store readings manually. For data logging see Option Menu page 21.

hold temp

Use with a temperature probe in order to hold the temperature reading.

Batteries Low: When the 'battery low' warning appears, the batteries must be replaced immediately, otherwise the readings obtained will be unreliable. If at any time the readings seem suspect, replace the batteries. For rechargeable instruments charge the internal batteries.

Instrument top view:

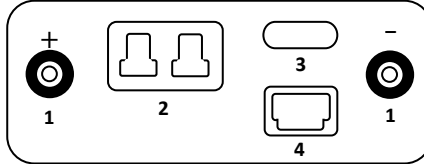

- 1:** Pressure ports. The instrument responds to positive, negative and differential pressure.
- 2:** K-type Thermocouple. Connect a K-type probe for temperature measurement. For temperature display see Temperature Mode Display page 08.
- 3:** Analogue Output. Cables for the Analogue Output are supplied as an optional extra. The minimum output is 0.0 V and the maximum output is 2.5 V. The user sets the corresponding pressure in Pascals. To set pressures see User Menu page 16. Connect the white cable to the positive and the black cable to the ground. The instrument will now give voltage output corresponding to the positive pressures.
- 4:** Mini USB port. For PC Connection used with DpmUsb Software to download data and for monitoring purposes. See Downloading Data page 24. For rechargeable instruments used with charger to charge the internal batteries.

Keypad view:



PRESSURE MODE DISPLAY

model dependent

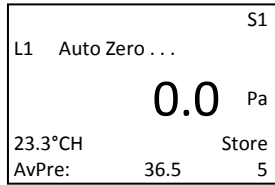

- S1** Speed.
There are 5 different speed settings.
Use the 'speed' key to toggle between speed settings.
- L1** Location number.
Store data in up to nine different Locations see Option Menu page 19.
The instrument will give an average value in the mode of operation for data that is stored in the same units of measurement and location.
When data is downloaded to a PC it will be listed under the Location in which it is stored.
- Auto Zero . . .** Whenever the Auto Zero sequence is initiated manually or at preset 'Auto Zero . . .' will be displayed until the cycle is complete.
- 0.0 Pa** Unit of Measurement.
Use the 'units' key or the ◀ and ▶ keys to toggle between units of measurement.
- 23.3°C** Temperature Probe reading.
This is not displayed when the temperature probe is not attached.
- H** When the 'hold temp' key is pressed 'H' will be displayed after the temperature reading, signalling that the temperature is being held.
The temperature will be held even if the probe is detached, until the 'hold temp' key is pressed a second time.
Pressing the 'hold temp' key a second time will release the temperature and if the probe is attached readings will continue to be taken as normal. If the probe is not attached, the instrument will use the default readings.
- Store** Number of readings stored.
5 Up to 4000 readings can be stored.
For information on storing data manually see Keypad Controls page 02.
For information on data logging see Option Menu page 21.
- AvPre: 36.5** Average Pressure of the stored readings.
An Average Pressure is taken for each Unit of Measurement in each Location.
This is then displayed on the screen. Stored values can be viewed in 'Review Results'.

model dependent

PT: 1.000	A:1	S1
L1	Auto Zero . . .	
	0.0	m/s
23.3°C		Store
AvVel:	5.6	5

- PT: 1.000** Pitot Tube Factor.
Up to 5 different Pitot Tube Factors can be stored.
To input Pitot Tube Factors see User Menu page 15.
To select a Pitot Tube Factor see Option Menu page 20.
- A:1** Area Setting.
Up to 5 different Area Settings can be stored.
To input Area Settings see User Menu page 14.
To select Area Settings see Option Menu page 19.
- S1** Speed.
There are 5 different speed settings.
Use the 'speed' key to toggle between speed settings.
- L1** Location number.
Store data in up to nine different Locations see Option Menu page 19.
The instrument will give an average value in the mode of operation for data that is stored in the same units of measurement and location.
When data is downloaded to a PC it will be listed under the Location in which it is stored.
- Auto Zero . . .** Whenever the Auto Zero sequence is initiated manually or at preset 'Auto Zero. . .' will be displayed until the cycle is complete.
- 0.0** m/s Unit of Measurement.
Use the 'units' key or the ◀ and ▶ keys to toggle between units of measurement.
- 23.3°C** Temperature Probe reading.
This is not displayed when the temperature probe is not attached.
- H** When the 'hold temp' key is pressed 'H' will be displayed after the temperature reading, signalling that the temperature is being held.
The temperature will be held even if the probe is detached, until the 'hold temp' key is pressed a second time.
Pressing the 'hold temp' key a second time will release the temperature and if the probe is attached readings will continue to be taken as normal. If the probe is not attached, the instrument will use the default readings.
- Store** Number of readings stored.
5 Up to 4000 readings can be stored.
For information on storing data manually see Keypad Controls page 02.
For information on data logging see Option Menu pages 21.
- AvVel: 5.6** Average Velocity of the stored readings.
An Average Velocity is taken for each Unit of Measurement in each Location.
This is then displayed on the screen. Stored values can be viewed in 'Review Results'.

model dependent

Live Volume can only be activated when Area Settings have been stored. See User Menu page 14.

To access the Live Volume Display press the ▼ key when in Velocity Mode.

To return to Velocity Mode press the ▲ key.

PT: 1.000	A:1	S1
L1 Auto Zero . . .		
	0.0	L/s
23.3°C		Store
AvVol: 47.5		5

- PT: 1.000** Pitot Tube Factor.
Up to 5 different Pitot Tube Factors can be stored.
To input Pitot Tube Factors see User Menu page 15.
To select a Pitot Tube Factor see Option Menu page 20.
- A:1** Area Setting.
Up to 5 different Area Settings can be stored.
To input Area Settings see User Menu page 14.
To select Area Settings see Option Menu page 19.
- S1** Speed.
There are 5 different speed settings.
Use the 'speed' key to toggle between speed settings.
- L1** Location number.
Store data in up to nine different Locations see Option Menu page 19.
The instrument will give an average value in the mode of operation for data that is stored in the same units of measurement and location.
When data is downloaded to a PC it will be listed under the Location in which it is stored.
- Auto Zero . . .** Whenever the Auto Zero sequence is initiated manually or at preset 'Auto Zero . . .' will be displayed until the cycle is complete.
- 0.0** L/s Unit of Measurement. The Live Volume is the Velocity multiplied by the Area.
For m/s the results are in L/s; for ft/min the results are in cfm.
In Live Volume Mode the units of measurement cannot be changed.
- 23.3°C** Temperature Probe reading.
This is not displayed when the temperature probe is not attached.
- H** When the 'hold temp' key is pressed 'H' will be displayed after the temperature reading, signalling that the temperature is being held.
The temperature will be held even if the probe is detached, until the 'hold temp' key is pressed a second time.
Pressing the 'hold temp' key a second time will release the temperature and if the probe is attached readings will continue to be taken as normal. If the probe is not attached, the instrument will use the default readings.
- Store**
5 Number of readings stored.
Up to 4000 readings can be stored.
For information on storing data manually see Keypad Controls page 02.
For information on data logging see Option Menu pages 21.
- AvVol: 47.5** Average Volume of the stored readings.
The Average Volume is a function of Velocity multiplied by Area, see page 11.

model dependent

+1.0/-1.0	S1
L1 Auto Zero . . .	
0.0	m3/ sec
23.3°C	Store
AvVol: 0.5	5

- +1.0/-1.0** K Factor.
Up to 4 different K Factors can be stored and a User Value can be temporarily input. To set default K Factors see User Menu page 15.
To select a K Factor or to input a temporary User Value see Option Menu page 20.
- S1** Speed.
There are 5 different speed settings.
Use the 'speed' key to toggle between speed settings.
- L1** Location number.
Store data in up to nine different Locations see Option Menu page 19.
The instrument will give an average value in the mode of operation for data that is stored in the same units of measurement and location.
When data is downloaded to a PC it will be listed under the Location in which it is stored.
- Auto Zero . . .** Whenever the Auto Zero sequence is initiated manually or at preset 'Auto Zero. . .' will be displayed until the cycle is complete.
- 0.0** m3/
sec Unit of Measurement.
Use the 'units' key or the ◀ and ▶ keys to toggle between units of measurement.
- 23.3°C** Temperature Probe reading.
This is not displayed when the temperature probe is not attached.
- H** When the 'hold temp' key is pressed 'H' will be displayed after the temperature reading, signalling that the temperature is being held.
The temperature will be held even if the probe is detached, until the 'hold temp' key is pressed a second time.
Pressing the 'hold temp' key a second time will release the temperature and if the probe is attached readings will continue to be taken as normal. If the probe is not attached, the instrument will use the default readings.
- Store** Number of readings stored.
5 Up to 4000 readings can be stored.
For information on storing data manually see Keypad Controls page 02.
For information on data logging see Option Menu pages 21.
- AvVol: 0.5** Average Volume of the stored readings.
An Average Volume is taken for each Unit of Measurement in each Location.
This is then displayed on the screen. Stored values can be viewed in 'Review Results'.

TEMPERATURE MODE DISPLAY

To access the Temperature Mode Display press the ▲ key while in Measurement Mode.
To return to Measurement Mode press the ▼ key.

Display with Temperature Probe:

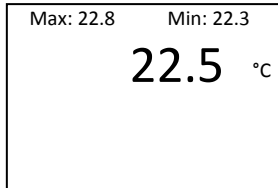

Max: 22.8 Maximum Probe Reading.

Min: 22.3 Minimum Probe Reading.

°C Unit of Measurement

Display without Temperature Probe:

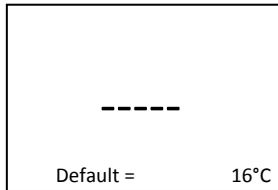

----- No Probe Attached

Default = Instrument Default Temperature.
16°C To change the default value, or to change the default setting from °C to °F,
see User Menu page 16.
To input a temporary value see Option Menu page 20.

- Gauge / Duct Static Measurement:** Connect to +. Leave – open to atmosphere. Readings may be positive or negative, depending on whether the system under test is above or below atmosphere pressure.
- Orifice Plates:** Connect upstream tapping to + and downstream tapping to –. Pressure readings should always be positive.
- Flow Grids:** Connect +Ve tapping to + and -Ve tapping to –. Pressure readings should always be positive.
- Inlet Cones:** Connect tapping to + using 'T' pieces to join the annular tapping together. Leave – open to atmosphere making sure that the open port is shielded against significant air movement from the ingoing airstream. Pressure readings should always be negative.
- Total Head Probe:** Connect to +. Leave – open. Readings should always be positive
- dpm Ane™:** Input Pitot tube factor 0.843. Connect clear tubing to + and blue tubing to –. Use the 'units' key to toggle to m/s or ft/min depending upon model. Readings should always be positive.
- dpm-i Pitot Tube:** Input the Pitot Tube factor 0.838. Connect clear tubing to + and black tubing to –. Use the 'units' key to toggle to m/s or ft/min depending upon model. Readings should always be positive.
- Ellipsoidal Pitot Tube:** Input the Pitot Tube factor 1.000. Connect clear tubing to + and black tubing to –. Use the 'units' key to toggle to m/s or ft/min depending upon model. Readings should always be positive.

Instrument top view:

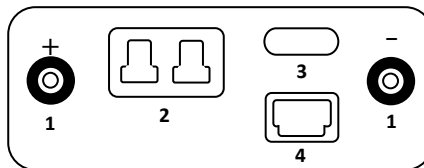

- 1: Pressure ports. The instrument responds to positive, negative and differential pressure.
- 2: K-type Thermocouple. Connect a K-type probe for temperature measurement. For temperature display see Temperature Mode Display page 08.
- 3: Analogue Output. Cables for the Analogue Output are supplied as an optional extra. The minimum output is 0.0 V and the maximum output is 2.5 V. The user sets the corresponding pressure in Pascals. To set pressures see User Menu page 16. Connect the white cable to the positive and the black cable to the ground. The instrument will now give voltage output corresponding to the positive pressures.
- 4: Mini USB port. For PC Connection used with DpmUsb Software to download data and for monitoring purposes. See Downloading Data page 24. For rechargeable instruments used with charger to charge the internal batteries.

VELOCITY

- dpm Ane™:** Input the Pitot Tube factor 0.843.
Connect the clear tubing to + and the blue tubing to –.
The ane should be placed into the air stream in the direction indicated by the arrows. Readings should always be positive.
If negative readings are obtained, there may be a leak or blockage in one of the pressure tubes, the tubes may be connected the wrong way round, or the measurements may be from an extract grille.
- dpm-i Pitot Tube:** Input the Pitot Tube factor 0.838.
Connect total pressure tapping to + and static pressure tapping to –.
The larger head located at the front of the dpm-i Pitot Tube must face directly into the oncoming air stream. Readings should always be positive.
If negative readings are obtained there may be a leak or blockage in one of the pressure tubes or the tubes may be connected the wrong way round.
- Ellipsoidal Pitot Tube:** Connect total pressure tapping to + and static pressure tapping to –.
The hole at the tip of the Pitot Static Tube must face directly into the oncoming air stream. Readings should always be positive.
If negative readings are obtained, there may be a leak or blockage in one of the pressure tubes or the tubes may be connected the wrong way round.
Most Pitot Static Tubes will give satisfactory results, but the NPL modified ellipsoidal pattern is particularly recommended.
The velocity range is calibrated at 'standard air' 1000 mbar / 16°C, for use with Total Head Probes and Pitot Static Tubes having a calibration factor unity. For non-standard air-conditions the barometric pressure and temperature can be set via the User Menu, see page 16 or the Option Menu, see page 20.

Air Velocity Calculations using S.I Scales:

For non-standard air conditions:
$$V = 1.291 \times PT \sqrt{\frac{1013.25 \times T}{B \times 289} \times Pv}$$

V = Velocity in m/sec

PT = Pitot Tube Factor (for Ellipsoidal type 1.000)

B = Barometric pressure in mbar

T = Absolute temperature in °K (= t in °C + 273 where t = airstream temperature)

Pv = Velocity pressure in Pa

Air Velocity Calculations using Imperial Scales:

For non-standard air conditions:
$$V = 4006 \times PT \sqrt{\frac{30 \times T}{B \times 521} \times Pv}$$

V = Velocity in ft/min

PT = Pitot Tube Factor (for Ellipsoidal type 1.000)

B = Barometric pressure in inHg

T = Absolute temperature in °R (= t in °F + 460 where t = airstream temperature)

Pv = Velocity pressure in wg

model dependent

First Method:

Select the duct shape and input the duct dimensions in millimetres or inches.
When data is stored in m/s or ft/min the Velocity Display shows the average velocity; in the Live Volume Display, this value is multiplied by the area to give the average volume.

To access the Live Volume Display press the ▼ key when in Velocity Mode.
To return to Velocity Mode press the ▲ key.

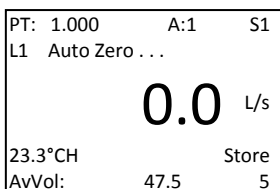

AvVol: Average Volume of the stored readings.
The Average Volume a function on Velocity multiplied by Area.

Second Method:

K Factor: The principle of calculation is to measure the differential pressure across the device, square root this value then multiply by the K Factor. The result is in m³/hr.
The K Factor is printed or obtained from the device manufacturer.
Alternatively, to determine the K Factor value: $K = (m^3/hr) / (VPD)$.

Connect the +Ve tapping to + and the -Ve tapping to -.
Instrument readings will be either in L/sec, m³/sec, m³/hr or cfm.
Readings should be positive.
If readings are meaningless there may be a leak or blockage in one of the pressure tubes or the tubes may be connected the wrong way round.

Hood: Apply the above procedure and enter the K Factors for the supply and exhaust into the instrument via the Option Menu see page 20.
Ensure that the display is in Volume Mode.
Connect the +Ve tapping to + and the -Ve tapping to -.
Now the instrument can be used as a Hood.

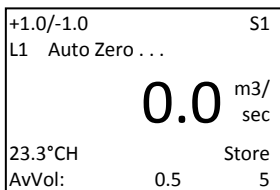

AvVol: Average Volume of the stored readings.
An Average Volume is taken for each Unit of Measurement in each Location.
This is then displayed on the screen. Stored values can be viewed in 'Review Results'.

USER MENU

The User Menu is used to input user values and change default settings.

To access the User Menu, switch on the instrument while holding down 

Page 12:

Set Clock: To set the clock to local time and input the date in the chosen format.

Page 13:

Auto Zero Period: This is factory set at 60 seconds.
(for which the instrument specifications are based)
Changing the default setting will override this.
A manual zeroing facility is available see Keypad Controls page 02.

Switch Off Period: To save battery the instrument is factory set to switch off after 10 minutes.
This can be overridden by changing the default setting.

Backlight Period: To increase or decrease the backlight time.

Page 14

Area Settings: (model dependent) Select either inches or millimetres and input the duct shape and dimension. Store up to 4 different Area Settings.

Note: If duct dimensions are input in inches, the instrument converts to millimetres in order to calculate the area, which is then converted into square feet.
This is the area shown in Review Results.

Page 15

Pitot Tube Factor: (model dependent) Store up to 4 Pitot Tube factors and the dpm Ane™ factor.

K Factor (model dependent) Store up to 2 different K factors and the dpm Hood factors.

Page 16

Temperature: Select a temperature unit and input a user temperature.

Barometer: Select a barometer unit and input the barometric pressure.

Analogue Output: Input the maximum and minimum output.

Page 17

Vel / Vol Readings: (model dependent) Select the decimal places for velocity and volume readings.

Set Brightness: Adjust the contrast settings for the instrument display.

Selecting from a list: Use ▲ and ▼ to scroll. Press  to select.

Entering a value: Use ▲ and ▼ to set each digit. Use ► to move on the next digit.
Press  to confirm.

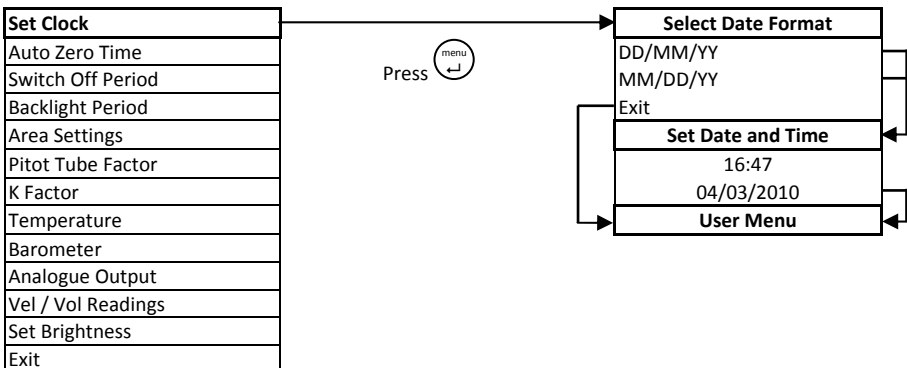

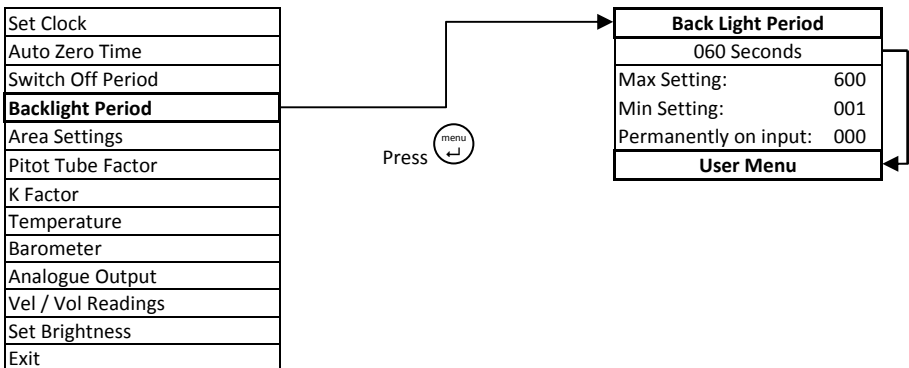
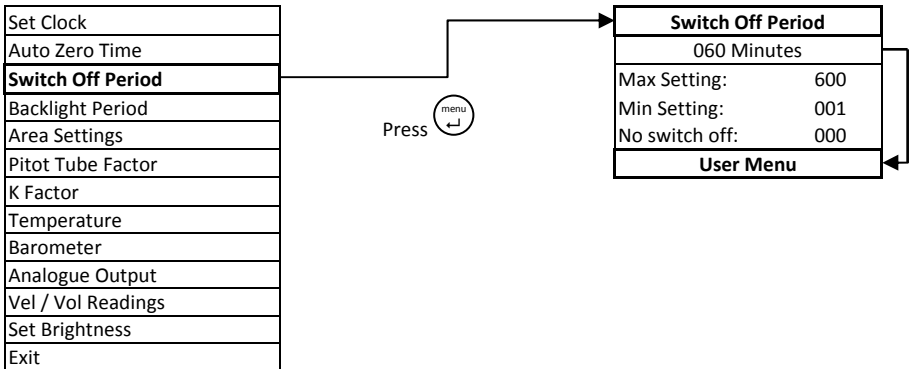
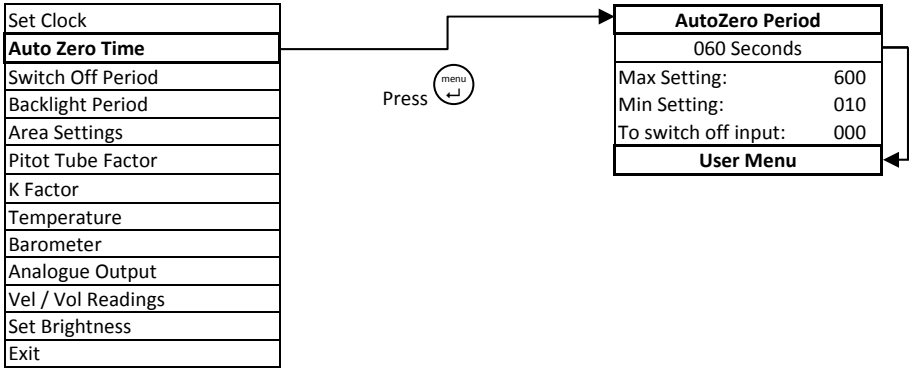

Selecting from a list: Use ▲ and ▼ to scroll. Press  to select.

Entering a value: Use ▲ and ▼ to set each digit. Use ► to move on the next digit.
Press  to confirm.



USER MENU

Selecting from a list: Use ▲ and ▼ to scroll. Press  to select.

Entering a value: Use ▲ and ▼ to set each digit. Use ► to move on the next digit.
Press  to confirm.

Set Clock
Auto Zero Time
Switch Off Period
Backlight Period
Area Settings
Pitot Tube Factor
K Factor
Temperature
Barometer
Analogue Output
Vel / Vol Readings
Set Brightness
Exit

Press 

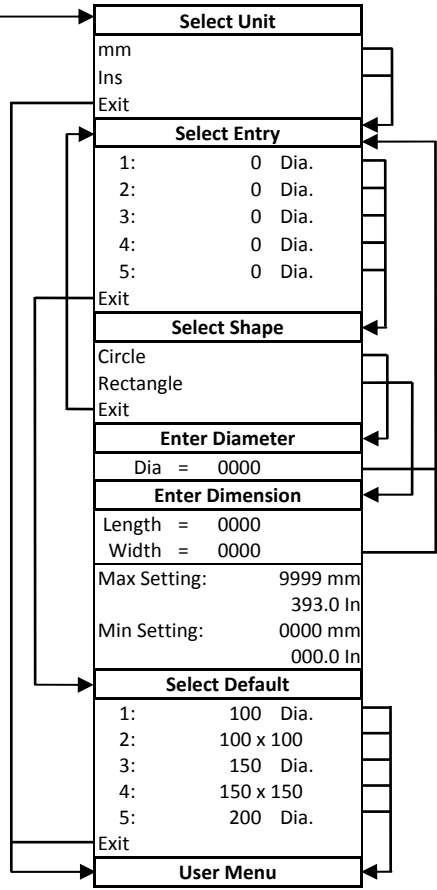

Selecting from a list: Use ▲ and ▼ to scroll. Press  to select.

Entering a value: Use ▲ and ▼ to set each digit. Use ► to move on the next digit.
Press  to confirm.

Set Clock
Auto Zero Time
Switch Off Period
Backlight Period
Area Settings
Pitot Tube Factor
K Factor
Temperature
Barometer
Analogue Output
Vel / Vol Readings
Set Brightness
Exit

Press 

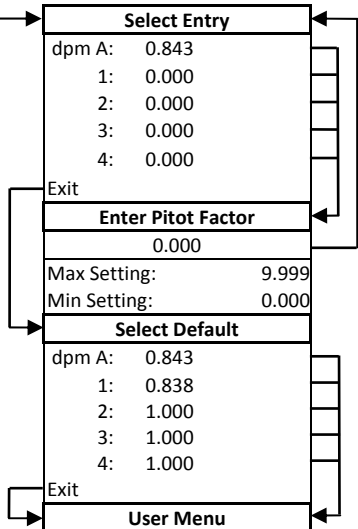

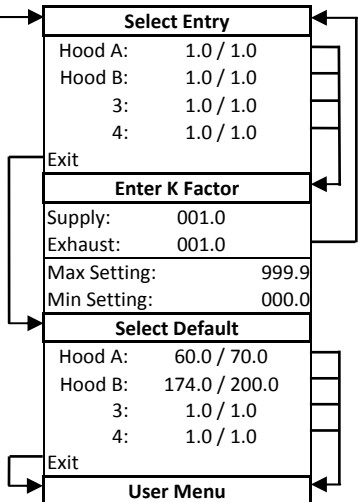

Set Clock
Auto Zero Time
Switch Off Period
Backlight Period
Area Settings
Pitot Tube Factor
K Factor
Temperature
Barometer
Analogue Output
Vel / Vol Readings
Set Brightness
Exit

Press 





USER MENU

Selecting from a list: Use ▲ and ▼ to scroll. Press  to select.

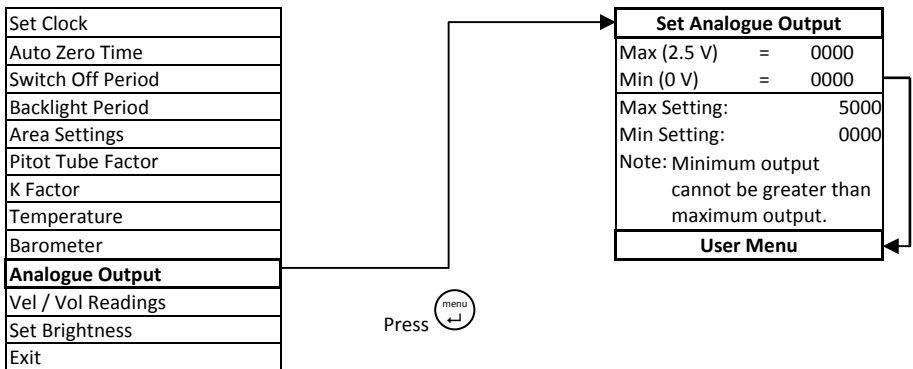
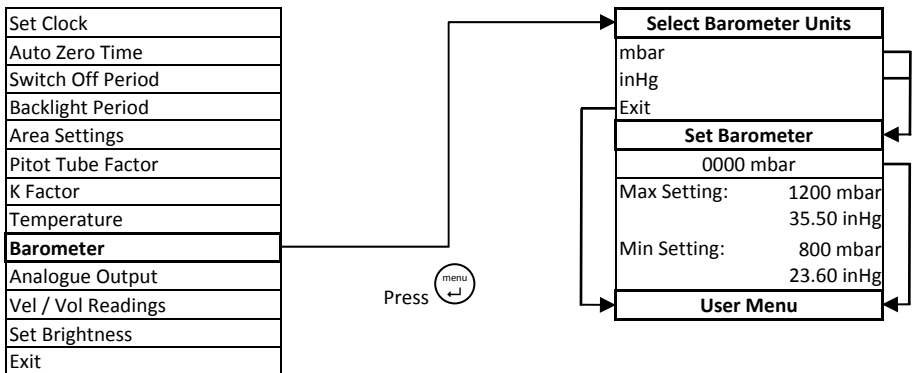
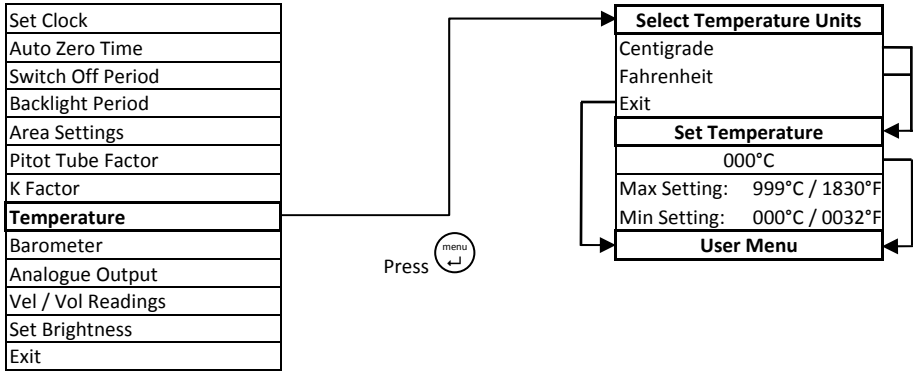
Entering a value: Use ▲ and ▼ to set each digit. Use ► to move on the next digit.
Press  to confirm.



Selecting from a list: Use ▲ and ▼ to scroll. Press  to select.

Entering a value: Use ▲ and ▼ to set each digit. Use ► to move on the next digit.
Press  to confirm.

Set Clock
Auto Zero Time
Switch Off Period
Backlight Period
Area Settings
Pitot Tube Factor
K Factor
Temperature
Barometer
Analogue Output
Vel / Vol Readings
Set Brightness
Exit

Press 

Vel / Vol Reading	
Decimal	
Points =	2
Max Setting:	2
Min Setting:	0
User Menu	

Set Clock
Auto Zero Time
Switch Off Period
Backlight Period
Area Settings
Pitot Tube Factor
K Factor
Temperature
Barometer
Analogue Output
Vel / Vol Readings
Set Brightness
Exit

Press 

Set Brightness	
Set 22	
Max Setting:	65
Min Setting:	0
User Menu	

Set Clock
Auto Zero Time
Switch Off Period
Backlight Period
Area Settings
Pitot Tube Factor
K Factor
Temperature
Barometer
Analogue Output
Vel / Vol Readings
Set Brightness
Exit

Press 

To Mode of Operation

OPTION MENU

The Option Menu is to temporarily change default settings.

Any settings changed in the Option Menu will be lost as soon as the instrument is switched off.

To access the Option Menu, press  when the instrument is in operation mode.

Page 18:

Review Results: View stored data in the form of time, measured value and unit of measurement. Use the  key to view further data on individual values.

Note: **In Review Results, when 'mix units' is shown this indicates a change of Location or units.**

Page 19:

Del Last Result: Deletes the last stored value.

Clear Memory: Deletes all stored data.

Set Location: Select a location in which to store data. The instrument will give an average value in the mode of operation only for data that is stored in the same Units of Measurement and Location. When data is downloaded to a PC it will be listed under the location in which it is stored.

Select Area: (model dependent) Select an area setting from a list of defaults.

Page 20

Select P Factor: (model dependent) Select a Pitot Tube factor from a list of defaults.



Select K Factor: (model dependent) Select a K factor from a list of defaults or input a User Value.





Set Temperature: Input a user temperature.

Page 21

Set Barometer: Input a user barometric pressure.

Start Recording: Store up to 4000 values at set intervals.

Selecting from a list: Use  and  to scroll. Press  to select.

Entering a value: Use  and  to set each digit. Use  to move on the next digit. Press  to confirm.

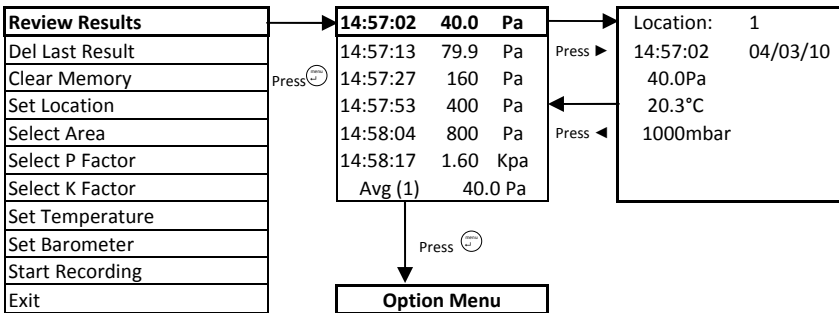

Selecting from a list: Use ▲ and ▼ to scroll. Press  to select.

Entering a value: Use ▲ and ▼ to set each digit. Use ► to move on the next digit.

Press  to confirm.

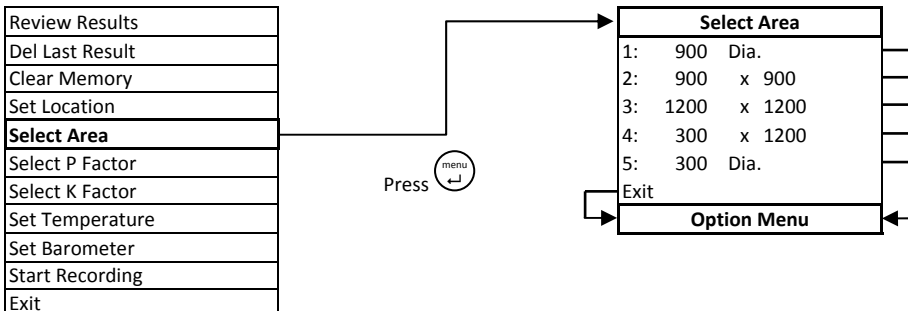
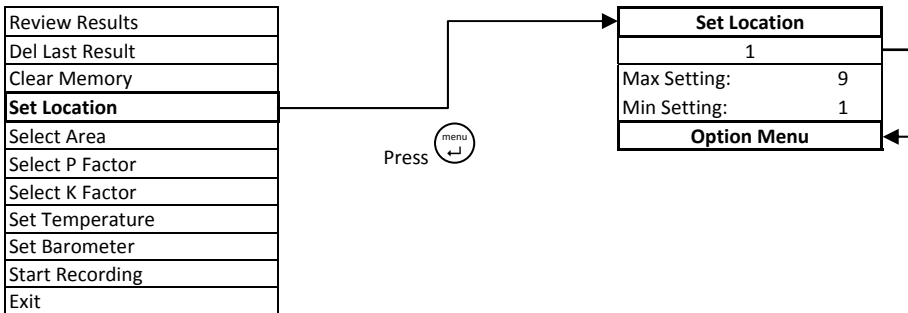
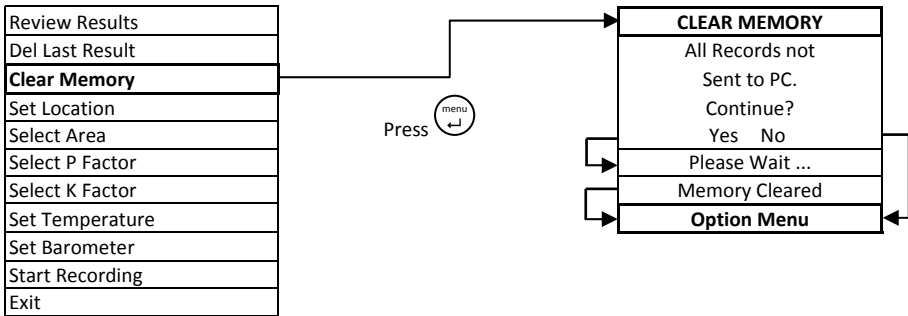
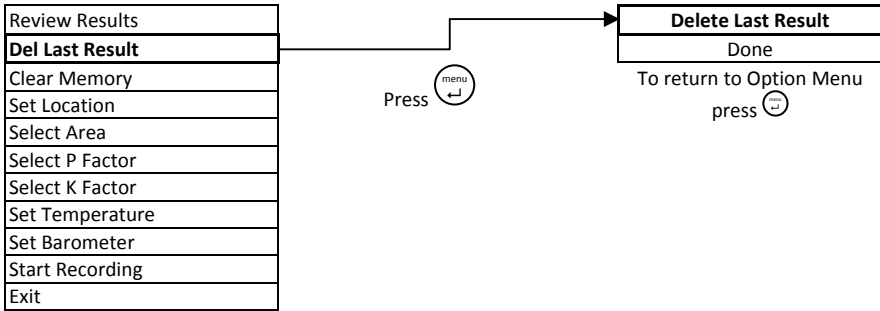



OPTION MENU

Selecting from a list: Use ▲ and ▼ to scroll. Press  to select.

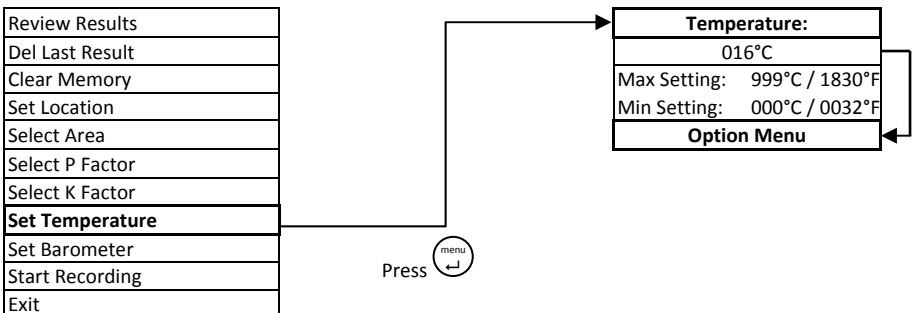
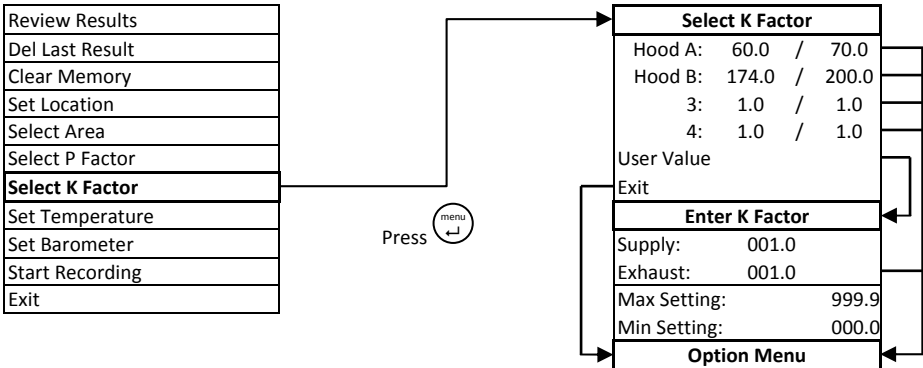
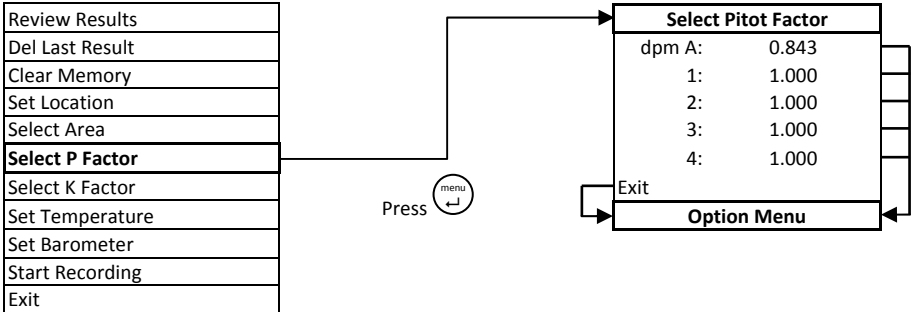
Entering a value: Use ▲ and ▼ to set each digit. Use ► to move on the next digit.
Press  to confirm.



Selecting from a list: Use ▲ and ▼ to scroll. Press  to select.

Entering a value: Use ▲ and ▼ to set each digit. Use ► to move on the next digit.
Press  to confirm.

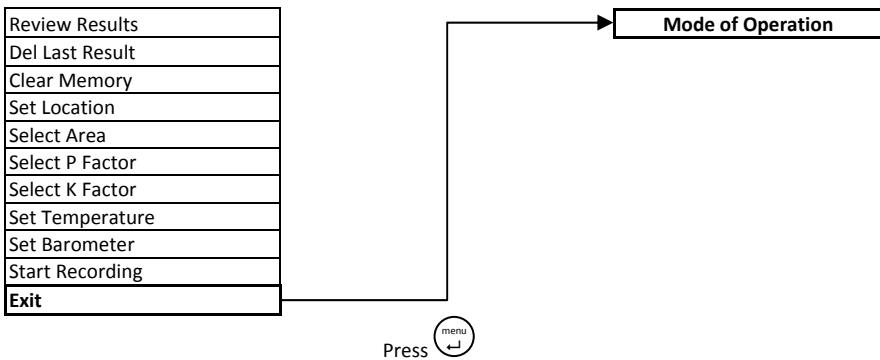
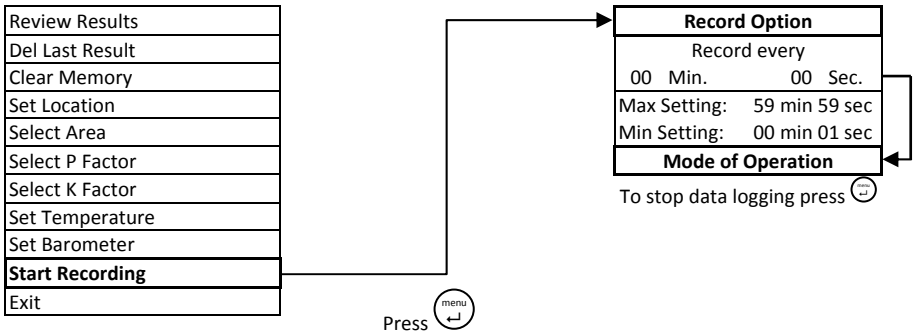
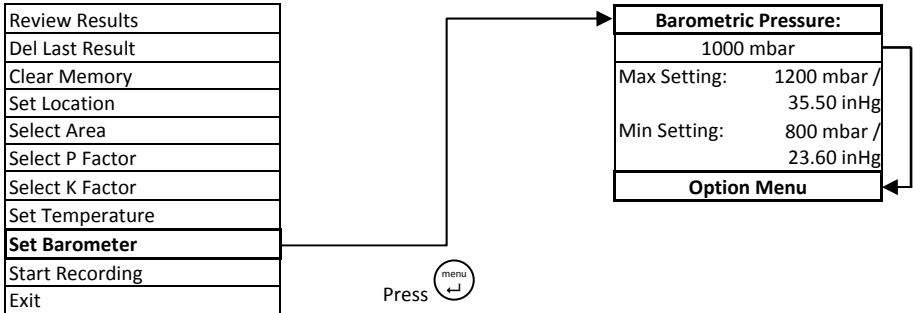

CONVERSION TABLES

Pressure:

	Pa	mbar	mmH ₂ O	inH ₂ O	mmHg	inHg	PSI
Pa	1	100.0	9.806	249.1	133.3	3385	6892
mbar	0.010	1	0.098	2.491	1.333	33.85	68.92
mmH ₂ O	0.102	10.20	1	25.40	13.60	345.42	702.8
inH ₂ O	0.004	0.402	0.039	1	0.535	13.51	27.67
mmHg	7.501×10^{-3}	0.750	0.074	1.868	1	25.64	51.70
inHg	2.953×10^{-4}	0.029	2.895×10^{-3}	0.074	0.039	1	2.305
PSI	1.451×10^{-4}	0.014	1.423×10^{-3}	0.036	0.019	0.4338	1

Volume:

	m ³ /sec	m ³ /hr	l/sec	cfm
m ³ /sec	1	0.0002	0.001	0.0004
m ³ /hr	3600	1	3.6	1.699
l/sec	999.97	0.2777	1	0.4719
cfm	2118.88	0.5885	2.1189	1

Velocity:

	m/sec	ft/min
m/sec	1	0.005
ft/min	196.85	1

Air Velocity Calculations using S.I Scales:

For non-standard air conditions: $V = 1.291 \times PT \sqrt{\frac{1013.25}{B} \times \frac{T}{289} \times Pv}$

V = Velocity in m/sec

PT = Pitot Tube Factor (for Ellipsoidal type 1.000)

B = Barometric pressure in mbar

T = Absolute temperature in °K (= t in °C + 273 where t = airstream temperature)

Pv = Velocity pressure in Pa

Air Velocity Calculations using Imperial Scales:

For non-standard air conditions: $V = 4006 \times PT \sqrt{\frac{30}{B} \times \frac{T}{521} \times Pv}$

V = Velocity in ft/min

PT = Pitot Tube Factor (for Ellipsoidal type 1.000)

B = Barometric pressure in inHg

T = Absolute temperature in °R (= t in °F + 460 where t = airstream temperature)

Pv = Velocity pressure in wg

Principle of Operation:

Pitot Head

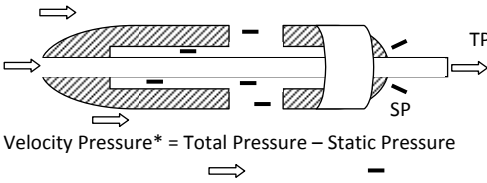

$$\text{Velocity Pressure}^* = \text{Total Pressure} - \text{Static Pressure}$$

* Calculated by the digital pocket manometer

The nose of the Pitot Tube should face directly into the airstream thus the Total Pressure flows down the inner tube which is connected to the Signal In port. The static holes are positioned around the side of the Pitot Tube and lead into an outer tube. This is connected to the black tubing which in turn is connected to the Reference port.

Log Linear Rule for Traverse Points on 3 Diameters in a Circular Duct:

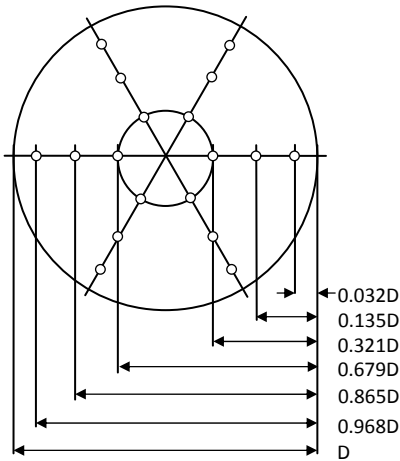

Ideally traverse points should be at least six duct diameters away from any bend or obstruction in the system.

The Pitot Tube should be inserted at right angles to the walls of the ducts and measurements are taken in the positions shown in the diagrams (left).

The directional pointer can be used to ensure that the Pitot Tube head is parallel to the duct walls.

Alternative Measuring Points and Traverse Lines Relative to Side Lengths for Regular Ducts:

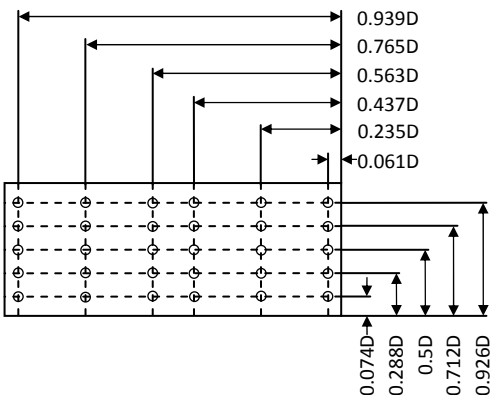

Important: DpmUsb Software is sold as an optional extra.
Only use a genuine cable and USB memory stick from DP Measurement.
If any other accessories or the incorrect downloading software are used then the guarantee on the instrument and the accessories becomes null and void.
All charges apply.

Download Data: The software must be installed and the cable must be connected to the PC.
Plug the mini USB into the instrument between the pressure ports.
Double click on the 'DpmUsb' icon. A message will appear on the screen. Click 'OK'. Give the file a name and check where it will be saved then click 'Save'.
Click 'Data' on the toolbar at the top of the screen. Under 'Data' click 'Load New'. A progress bar will appear on the screen followed by a message that reads 'All data successfully loaded. Erase from the Unit?' It is recommended to click 'No'. The cable can be disconnected from the instrument.
The data is stored now stored on the PC under the same Location number(s) as it is stored on the instrument. The data is non-editable.

Export Data: Click 'File' on the toolbar at the top of the screen. Under 'File' click 'Export csv file'. Give the file a name and check where it will be saved then click 'Save'.
Open the file in Excel.

Further information on the DpmUsb software can be found in the software help file.

Maintenance: There are no user serviceable parts in the digital pocket manometer.
With the exception of dry cell batteries there are no consumable parts.
If the instrument is damaged or requires servicing it should be returned to the Buckingham England factory.

Calibration: All ST6 instruments are calibrated against equipment traceable to National Standards. It is good practice to have the instrument calibrated and checked at least once a year. The Buckingham England factory offers a calibration service; see address below.



In the interest of continuous product development and improvement DP Measurement reserve the right to amend specifications and to discontinue models, features and colours of the ST6 Series Micromanometers at any time without prior notice



DP Measurement

Unit 11, Top Angel, Buckingham Industrial Park

Buckingham, England. MK18 1TH

Tel / Fax: +44 (0)1280 817122

www.ttseries.com email: dpm@ttseries.com

Models:
Range / Resolution:

ST6 M	ST6 I	Ane	ST610 - Hood	ST610 - Hood	
●					Pressure:
●					Pa ± 0.4 to 999.9 ± 1000 to 5000
●					KPa ± 0.4 to 99.9 Pa ± 100 to 999 Pa ± 1.00 to 5.00 KPa
●					mbar ± 0.000 to 0.999 ± 1.00 to 9.99 ± 10.0 to 50.0
					mmH ₂ O ± 0.000 to 0.999 ± 1.00 to 9.99 ± 10.0 to 99.9 ± 100 to 510
	●				inH ₂ O ± 0.000 to 0.999 ± 1.00 to 9.99 ± 10.0 to 20.0
●					mmHg ± 0.000 to 0.999 ± 10.00 to 37.51
	●				inHg ± 0.000 to 0.999 ± 1.00 to 1.47
	●				PSI ± 0.000 to 0.726
					Velocity:
					dpm Ane™ head dpm - i Pitot Tube Ellipsoidal Pitot Tube
●			●		m/sec 0.70 to 25.0 0.70 to 90.0 0.70 to 90.0
	●		●		ft/min 138 to 4921 138 to 17730 138 to 17730
					Volume (Hood mode): Plate A Plate B
			●		L/sec Supply / Exhaust 13.0 to 100 35.0 to 555
			●		m ³ /hr Supply / Exhaust 45.0 to 360 127 to 1998
			●		cfm Supply / Exhaust 26.0 to 212 75.0 to 1176
					Temperature (with K – type probe):
●	●	●	●		°C ± 0.0 to 500.0
●	●	●	●		°F ± 0 to 932

Accuracy:
Pressure at 20°C and Velocity with Ellipsoidal Type Pitot Tube at 16°C, 1000 mbar:

Readings < 100 counts ± 2 counts. Readings > 100 counts ± 1% of reading ± 1 count

Velocity with dpm - i Type Pitot Tube at 16°C, 1000 mbar:

± 3% of reading or ± 0.05 m/sec (10 ft/min) ± 1 count whichever is greater.

Velocity with dpm-Ane™ at 16°C, 1000 mbar:

Readings up to 8 m/sec (1575 ft/min) ± 1% of reading ± 0.03 m/sec.

Readings from 8 to 25 m/sec (1575 to 4921 ft/min) ± 1 m/sec (197 ft/min)

Volume at 16°C, 1000 mbar:

With Adaptor Plate A and appropriate settings:

Flow < 40 L/sec (144 m³/hr, 85 cfm) ± 3% of reading ± 2 L/sec (7.2 m³/hr, 4.2 cfm)

With Adaptor Plate B and appropriate settings:

Flow > 40 L/sec (144 m³/hr, 85 cfm) ± 3% of reading 4 L/sec (14 m³/hr, 9 cfm)

Temperature at 20°C:

± 2°C (36°F)

SPECIFICATIONS

Recommended Operational Limits:	0° to 50°C (32° to 123°F)	
Span Stability versus Temperature:	0.1% of range in use per °C (per 2°F)	
Zero Drift:	Negligible due to Auto Zero system. When Auto Zero set at 60 sec intervals (2 minute warm up).	
Zero System Accuracy:	± 0.05 Pascal typical	
Orientation Effect:	(any 45° change) 0.1 Pascal typical	
Output Socket:	Miniature USB port.	
Data Logging:	Up to 4000 any units.	
Software:	Download data to PC using DpmUsb software.	
Power Source:	Dry cell (AA) or Rechargeable.	
Battery Life:	22 hours (depending upon battery) With Auto Zero at 60 sec intervals and backlight permanently on.	
System Air Leak:	0.01 ml/minute a 5Kpa (typical)	
Safe Line / Differential Pressure:	15KPa	
Storage Temperature Limits:	-5° to +50°C	
Weight:	360 grammes with batteries and holster.	
Dimensions:	145 x 85 x 50 mm with holster	
Standard Accessories:	2mm x 6mm tubing adaptors (4) 3m x 2mm bore flexible tubing (2) Calibration certificate	Instruction manual Rubber holster Soft lined case
Optional Extras:	Analogue Output dpm ane™ dpm Hood™ dpm Short Hood	DpmUsb software Pitot Static Tubes Temperature Probes USB cable



Calibration certificate is traceable to National Standards.
In the interest of continuous product development and improvement DP Measurement reserve the right to amend specifications and to discontinue models, features and colours of the ST6 Series Micromanometers at any time without prior notice.



DP Measurement

Unit 11, Top Angel, Buckingham Industrial Park
Buckingham, England. MK18 1TH
Tel / Fax: +44 (0)1280 817122
www.ttseries.com email: dpm@ttseries.com