

Simply a question of
better measurement



SCHMIDT® Flow Sensor
SS 20.700
Instructions for Use

SCHMIDT® Flow Sensor SS 20.700

Table of Contents

1	Important information.....	3
2	Application range.....	4
3	Mounting instructions.....	6
4	Electrical connection.....	17
5	Signaling.....	22
6	Commissioning.....	28
7	Information concerning operation.....	28
8	Service information.....	29
9	Dimensions.....	32
10	Technical data.....	33
11	Declarations of conformity.....	35

Imprint:

Copyright 2022 **SCHMIDT Technology GmbH**

All rights reserved

Version: 568365.02

Subject to modifications

1 Important information

The instructions for use contain all required information for a fast commissioning and a safe operation of **SCHMIDT®** flow sensors.

- These instructions for use must be read completely and observed carefully, before putting the unit into operation.
- Any claims under the manufacturer's liability for damage resulting from non-observance or non-compliance with these instructions will become void.
- Tampering with the device in any way whatsoever - with the exception of the designated use and the operations described in these instructions for use - will forfeit any warranty and exclude any liability.
- The unit is designed exclusively for the use described below (refer to chapter 2). In particular, it is not designed for direct or indirect protection of personal or machinery.
- **SCHMIDT Technology** cannot give any warranty as to its suitability for a certain purpose and cannot be held liable for errors contained in these instructions for use or for accidental or sequential damage in connection with the delivery, performance or use of this unit.

Symbols used in this manual

The symbols used in this manual are explained in the following section.



Danger warnings and safety instructions. Read carefully!

Non-observance of these instructions may lead to injury of personal or malfunction of the device.

General note

All dimensions are given in mm.

2 Application range

The **SCHMIDT® Flow Sensor SS 20.700** (art. no.: 562 140) is designed for stationary measurement of the flow velocity as well as the temperature of air and gas with operating temperature from -20 ... +120 °C and working pressure¹ up to 16 bar.

The sensor is based on the measuring principle of a thermal anemometer and measures the mass flow of the measuring medium as flow velocity which is output in a linear way as standard velocity² w_N (unit: m/s), based on standard conditions of 1013.25 hPa and 20 °C. Thus, the resulting output signal is independent of the pressure and temperature of the medium to be measured.



When using the sensor outdoors, it must be protected against direct exposure to the weather.

Versions „Oxygen (O₂) > 21 %“ and „Grease-free and Oxygen (O₂) > 21 % (PWIS-free)“

- The variant "*Oxygen (O₂) > 21 %*", which is suitable for use in concentrated oxygen, differs constructively from the standard version only by the use of a special compression fitting. Its sealing O-ring consists of BAM³-approved FKM which is coated with an oxygen-suitable lubricant.
- The variant "*Grease-free and Oxygen (O₂) > 21 % (PWIS-free)*" is also suitable for the use in concentrated oxygen but in addition its completely free of any lubricant. Aside from that the seal of the compression fitting is realized with a clamping ring made of stainless steel thus there are no synthetics which comes in contact with the medium. The sensor can also be used in applications where paint-wetting impairment substances (PWIS) are not acceptable.

The sensor, its accessories and the packaging have been cleaned especially according to the standard IEC/TR 60877:1999.

This standard restricts the use of the sensor to biatomic oxygen O₂ (small residual amounts of ozone are acceptable nevertheless).



Improper handling of gas mixtures with an oxygen content of more than 21 % or pure oxygen can lead to fires or explosions.

¹ Overpressure

² Corresponds to the actual velocity under standard conditions

³ BAM: Bundesanstalt für Materialforschung und –prüfung (german federal authority)



It is explicitly pointed out that the customer, by opening the packaging, assumes full responsibility for the cleanliness of both the sensor as well as its accessories according to the standard IEC/TR 60877:1999.

Information concerning O₂ compliant handling

The general rule is that a soiling of sensor parts that come into contact with oxygen must be absolutely avoided:

- The installation site must be carefully cleaned before mounting of the sensor.
- Make sure to use only clean tools and material for the installation.
- Before opening the packaging film, remove the dirt such as dust from the film, if necessary.
- If possible, open the packaging film and take out the sensor directly at the installation site.
- Otherwise open the packaging film at an appropriate and clean workplace and store the sensor in an appropriate, cleaned, dust- and humidity-tight container.
- Do not touch the oxygen contacting sensor parts with bare hands.
- Use clean and non-fluffy gloves or cloths or similar to handle the sensor.

Version for “special gases”

The version of the **SS 20.700** for “special gases” receives a gas-specific adaption for the measurement of certain gases and gas mixtures.

The sensor is adjusted and calibrated in air. Then a special correction function for the medium to be measured is applied to the sensor. This correction has been determined for many gases in real gas ducts. For gas mixtures, the correction adaption is calculated according to the set volumic mixing ratio.



The customer is responsible for observing all relevant statutory provisions, standards and directives relating to the use of gases.

Mechanical versions

The sensor **SS 20.700** is available in two versions:

- Compact sensor:
The sensor probe is fixed to the main enclosure.
- Remote sensor:
The sensor probe is mechanically separated from the main enclosure. Connection is realized by an electrical signal cable that cannot be detached on either side.

The different construction types and their dimensions can be found in the dimensional drawings in chapter 9.

3 Mounting instructions

General information on handling

The flow sensor **SS 20.700** is a precision instrument with high measuring sensitivity. In spite of the robust construction of the sensor head, soiling of the sensor elements can lead to distortion of measurement results (see also chapter 8).

During procedures such as transport, installation or dismantling of the sensor that facilitates soiling as well as represent a mechanical load on the sensor head, it is generally necessary to attach the enclosed protective cap of **SCHMIDT Technology** to the sensor head and remove it only during operation.



To avoid soiling and mechanical stress on the sensor head, the protective cap should be placed over it during transport or installation.

Mounting method

The sensor **SS 20.700** can be mounted only by means of a compression fitting which supports the sensor tube and ensures frictional clamping. The compression fitting as well as a pressure protection kit is included in the scope of delivery.

Due to the variety of applications the compression fitting exists in different versions. On the one hand they are determined by the design of the external thread (order option: G $\frac{1}{2}$ or R $\frac{1}{2}$), on the other hand by the materials and properties of the sealing:

- Standard: O-Ring (NBR)
- Oxygen (O₂): O-Ring (FKM, BAM approved)
- Grease-free: Clamping ring (stainless steel)

Systems with overpressure

The **SS 20.700** is designed for a maximum working pressure of 16 bar.

As long as the medium to be measured is operated with overpressure, make sure that:

- There is no overpressure in the system during mounting.



Mounting and dismantling of the sensor can be carried out only as long as the system is **in a depressurized state**.

- Only suitable pressure-tight mounting accessories are used.
- Appropriate safety measures are installed to avoid unintended discarding of the sensor due to overpressure. If other accessories than the delivered pressure protection kit or alternative mounting solutions are used, the customer must ensure the corresponding safety measures.



For measurements in media with overpressure, appropriate safety measures must be taken to prevent unintended discarding of the sensor.



The pressure-tight mounting, the fastening of the screw pipe connection and the discarding protection must be checked before pressure is applied. These tightness checks must be repeated at reasonable intervals.



The components of the pressure protection kit (bolt, chain and bracket) have to be checked regularly for integrity.

Thermal boundary conditions

In the case of medium temperatures that don't correspond to the permissible operating temperature of the electronics, cross-talk of the temperature into the electronics housing must be prevented by a thermal decoupling section of the sensor tube having a free-standing length of at least 50 mm (see Figure 3-1) or by means of other suitable measures.

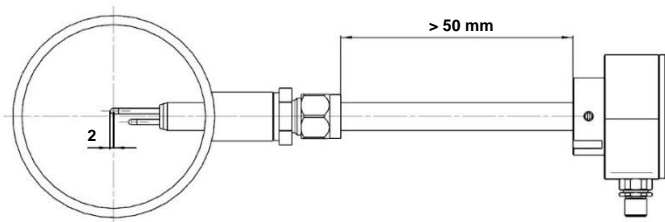

Figure 3-1



The permissible operating temperature range of the electronics must not be exceeded by crosstalk of the medium temperature on the sensor housing.

Flow characteristics

Local turbulences of the medium can cause distortion of measurement results. Therefore, appropriate mounting conditions must be guaranteed to ensure that the gas flow is supplied to the sensor in a laminar⁴ state, i.e. quiet and low in turbulence. The corresponding measures depend on the system properties (pipe, chamber, etc.) which are described in the following subchapters for different mounting variants.



Correct measurements require a (laminar) flow, low in turbulence.

⁴ The term "laminar" means here an air flow, low in turbulence (not according to its physical definition saying that the Reynolds number is < 2300).

General installation conditions

The sensor head of the **SS 20.700** consists of two basic elements:

- Heater
The longer of the two sensor tubes at the tip of the sensor head is the so-called heater. It consists of a heated, temperature-dependent resistor that is used to measure flow velocity.
The end of the heater element, to which the length specification (L) of the sensor also refers, represents the actual measuring point of the flow measurement and should be placed as favourably as possible in the flow, e.g. in the middle of the pipe.
- Temperature sensing element
The shorter of the two sensor tubes at the tip of the sensor head is the temperature sensor. It consists of an unheated, temperature-dependent resistor, which measures the temperature of the medium.

The aerodynamically optimized design allows tilting around the longitudinal axis of the sensor up to $\pm 3^\circ$ relative to the ideal measuring direction (see Figure 3-2) without significant impact on the measurement result⁵.



The axial tilting of the sensor head relative to the flow direction should not exceed $\pm 3^\circ$.



Position the sensor head always at the most advantageous position for flow measurement.



The sensor measures unidirectional (see “flow arrow” in Figure 3-2) and must be adjusted correctly relative to the flow direction.

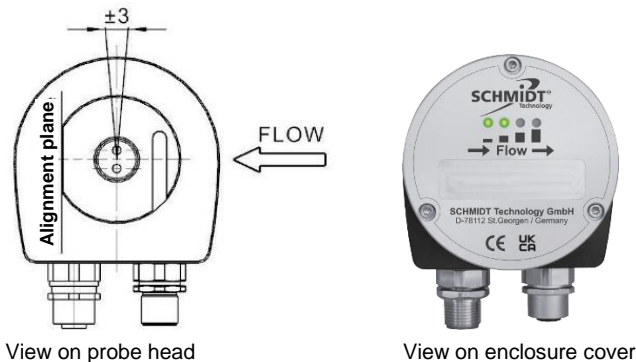

Figure 3-2 Alignment of sensor to flow direction

⁵ Deviation < 1 % of the measured value

Mounting in pipes with circular cross-section

Typical applications for this type are compressed air networks or burner gas supply lines. They are characterized by long thin pipes with a typically quasi-parabolic flow profile.

The easiest method to achieve a low-turbulence flow is to provide a sufficiently long and absolutely straight distance without disturbances (such as edges, seams, bends etc.) in front (inlet) and behind the sensor (outlet) (see installation drawing Figure 3-3). It is also necessary to pay attention to the design of the outlet distance because the flow is also influenced by disturbances generating turbulences against the flow direction.

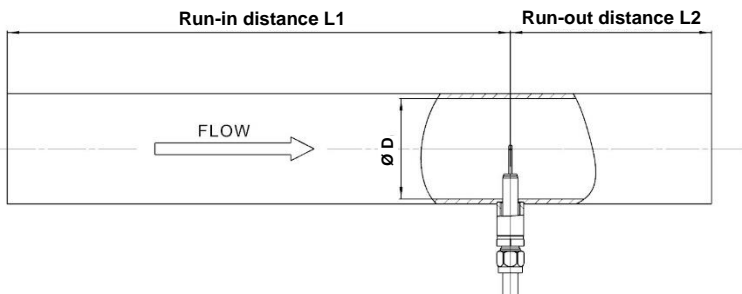

Figure 3-3

- L1 Length of run-in distance
- L2 Length of run-out distance
- D Inner diameter of measuring distance

The absolute length of the corresponding distances is defined by the inner diameter of the pipe because the flow abatement depends directly on the aspect ratio of measuring distance and diameter. Therefore, the required abatement distances are specified as a multiple of the inner pipe diameter D . Besides, the degree of turbulence generation by the corresponding disturbing object plays an important role. A slightly curved bend directs the air with a relative low-disturbance level, whereas a valve generates massive turbulences with its abrupt change of the flow-guiding cross-section, requiring a relatively long distance for abatement.

The following Table 1 shows the required straight pipe lengths depending on the inner tube diameter D and different causes of disturbances.

This table lists the minimum values required in each case. If the listed straight pipe lengths cannot be achieved, measurement accuracy may be impaired or additional actions are required like the use of flow rectifiers⁶.

⁶ E.g., honeycombs made of plastic or ceramics.

Flow obstacle upstream of measuring distance		Minimum distance length of	
		Run-in (L1)	Run-out (L2)
Light bend (< 90°)		10 x D	5 x D
Reduction expansion 90° bend T-junction		15 x D	5 x D
Two 90° bends in one plane (2-dimensional)		20 x D	5 x D
Two 90° bends with 3-dimensional change in direction		35 x D	5 x D
Shut-off valve		45 x D	5 x D

Table 1 Run-in and run-out distances

The profile factors specified in Table 2 may become void by the use of flow rectifiers.

Calculation of volume flow

A quasi-parabolic speed profile is formed over the pipe's cross-section under laminar conditions. Whereas the flow velocity at the pipe walls remains almost zero, in the middle of the pipe it reaches the optimum measuring point, its maximum w_N . This measured variable can be converted into an average flow velocity $\overline{w_N}$ that is constant over the pipe cross-section with the aid of a correction factor the so-called profile factor PF. The profile factor depends on the inner pipe diameter⁷ (see Table 2).

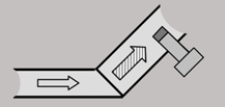
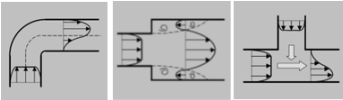
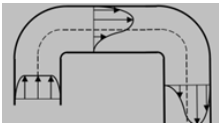
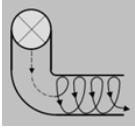
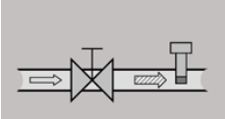
PF	Pipe Ø		Volume flow [m³/h]						
	Inner [mm]	Outer [mm]	Min. @	@ Sensor measuring range					
			0.2 m/s	10 m/s	20 m/s	60 m/s	90 m/s	140 m/s	220 m/s
0.748	39.3	44.5	0.7	32.7	65.3	196.0	294.0	457.3	718.6
0.772	51.2	57.0	1.1	57.2	114.4	343.3	515.0	801.1	1258
0.786	70.3	76.1	2.2	109.8	219.7	659.0	988.5	1537	2416
0.797	82.5	88.9	3.1	153.4	306.8	920.3	1380	2147	3374
0.804	100.8	108.0	4.6	231.0	462.0	1385	2078	3233	5081
0.812	125.0	133.0	7.2	358.7	717.5	2152	3228	5022	7892
0.817	150.0	159.0	10.4	519.8	1039	3118	4677	7276	11434
0.829	206.5	219.1	20.0	999.5	1999	5997	8995	13993	21989
0.835	260.4	273.0	32.0	1700	3201	9605	14408	22412	35219
0.840	309.7	323.9	45.6	2278	4556	13668	20502	31892	50116
0.841	339.6	345.6	54.8	2742	5484	16454	24681	38393	60331
0.845	388.8	406.4	72.2	3611	7223	21669	32504	50562	79455
0.847	437.0	457.0	91.5	4573	9146	27440	41160	64027	100614
0.850	486.0	508.0	113.5	5676	11353	34059	51088	79471	124883
0.852	534.0	559.0	137.4	6869	13738	41216	61824	96170	151125
0.854	585.0	610.0	165.3	8263	16526	49580	74371	115688	181796
0.860	800.0		311.2	15562	31124	93373	140059	217870	342368
0.864	1000		488.6	24429	48858	146574	219861	342006	537438
0.872	1500		1109	55474	110948	332845	499268	776639	1220433
0.877	2000		1983	99186	198372	595118	892677	1388609	2182100

Table 2 Profile factors and volume flows of different pipe diameters

⁷ Both inner air friction and sensor locking are responsible.

Thus, it is possible to calculate the standard volume flow of the medium using the measured standard flow velocity in a pipe with known inner diameter:

$$A = \frac{\pi}{4} \cdot D^2$$

$$\bar{w}_N = PF \cdot w_N$$

$$\dot{V}_N = \bar{w}_N \cdot A$$

D	Inner diameter of pipe [m]
A	Cross-section area of pipe [m ²]
w_N	Flow velocity in the middle of the pipe [m/s]
\bar{w}_N	Average flow velocity in the pipe [m/s]
PF	Profile factor (for pipes with a circular cross-section)
\dot{V}_N	Standard volume flow [m ³ /s]

SCHMIDT Technology provides a "flow calculator" on its homepage for the calculation of flow velocity or volume flow in (circular) pipes or (rectangular) ducts for the different sensor types:

www.schmidt-sensors.com or www.schmidttechnology.de

Installation in systems with square cross-section

For most applications, two limit cases can be distinguished with regard to flow conditions:

- Quasi-uniform flow field

The lateral dimensions of the flow-guiding system are approximately as large as its length in the flow direction and the flow velocity is small so that a stable trapezoidal⁸ speed profile of the flow is formed. The width of the flow gradient zone at the wall is negligible in relation to the chamber width so that a constant flow velocity can be expected over the whole chamber cross-section (in this case the profile factor is 1). The sensor must be mounted here so that its sensor head, located at a sufficient distance from the wall, measures in the area with the constant flow field.

Typical applications are:

- Exhaust ventilation ducts for drying processes
 - Chimneys
 - Open spaces
- Quasi-parabolic flow profile

The system length is large compared to the cross-section surface and the flow velocity is so high that the ratios correspond to that of the circular pipe. This means that the same requirements apply here to the installation conditions.

⁸ A uniform flow field prevails in the largest part of the space cross-section.

Since the situation is similar to that in a pipe⁹, the volume flow in a square chamber can be calculated by equating the hydraulic diameter of both cross-section forms.

A rectangular duct (see Figure 3-4) has a hydraulic “pipe diameter” D_H :

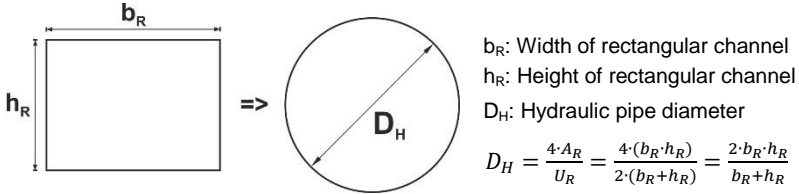

Figure 3-4

According to this, the volume flow in this duct is calculated as:

$$A_H = \frac{\pi}{4} \cdot D_H^2 = \frac{\pi}{4} \cdot \left(\frac{2 \cdot b_R \cdot h_R}{b_R + h_R} \right)^2 = \pi \cdot \left(\frac{b_R \cdot h_R}{b_R + h_R} \right)^2$$

$$\bar{w}_N = PF \cdot w_N$$

$$\dot{V}_N = \bar{w}_N \cdot A_H = PF \cdot \pi \cdot \left(\frac{b_R \cdot h_R}{b_R + h_R} \right)^2 \cdot w_N$$

b_R/h_R	Width/height of the square chamber [m]
D_H	Hydraulic inner diameter of the chamber [m]
A_H	Cross-section area of the equivalent pipe [m ²]
w_N	Maximum flow velocity in the middle of the duct / pipe [m/s]
\bar{w}_N	Average flow velocity in the pipe [m/s]
PF	Pipe profile factor
\dot{V}_N	Standard volume flow [m ³ /s]

Typical applications are:

- Ventilation ducts
- Exhaust air ducts

⁹ The profile factors are equal for both cross-section forms.

Mounting with compression fitting

The compression fitting is mounted using its external thread (G $\frac{1}{2}$ or R $\frac{1}{2}$). Typically, a bushing (sleeve) is welded as a fitting onto a bore in the medium-guiding system wall. In most applications, latter are pipes which are taken as an example for description of the mounting procedure below (details see Figure 3-5).

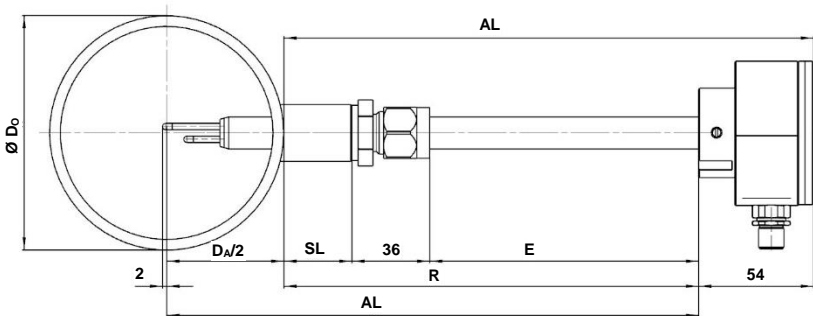

Figure 3-5

<i>L</i>	Probe length [mm]	<i>D_o</i>	Outer diameter of pipe [mm]
<i>SL</i>	Length of weld-in sleeve [mm]	<i>E</i>	Sensor tube setting length [mm]
<i>AL</i>	Projecting length [mm]	<i>R</i>	Reference length [mm]

Installation process:



Depressurize the system for measurements with overpressure media and mount the pressure protection kit.

- Drill a mounting bore in pipe wall.
- Weld pipe sleeve with an internal thread G $\frac{1}{2}$ or R $\frac{1}{2}$ on to the pipe, in the center above the mounting bore.
Recommended length of sleeve: 15 ... 40 mm
- Plug holding bracket of pressure protection chain into thread of the compression fitting.
- Screw threaded part of compression fitting tightly into the pipe sleeve (hexagon AF27).
 - Observe correct seat and alignment of chain bracket.
 - Check if there is an O-ring seal available and if it is fitted tightly.
- Unscrew spigot nut of compression fitting so that the sensor probe can be inserted without jamming.
- Remove protective cap from sensor head. Carefully insert sensor into the duct of the compression fitting so that the end of the heater (longer tube) is positioned in the middle of the pipe.

- Adjust sensor manually at sensor enclosure by turning it counterclockwise by approx. 80° to flow direction (observe flow arrow on enclosure cover). Make sure that immersion depth is maintained.
- Tighten spigot nut slightly by means of a key wrench (AF24) to fasten the sensor.
- Apply a key wrench (AF27) to hexagon bolt of the compression fitting to lock it. Use another key wrench (AF24) to tighten spigot nut of the compression fitting until the arrow on the sensor enclosure complies with the direction of the pipe flow.
- Check the set angular position carefully, for example by placing a bubble level on the alignment plane of the sensor enclosure.



The angular deviation should not be more than $\pm 3^\circ$, related to the ideal measuring direction. Otherwise, measurement accuracy may be affected.

- In case of wrong adjustment, the compression fitting has to be loosened and the alignment procedure must be repeated.
- Shorten safety chain by removing superfluous chain links so that the chain is slightly tensioned after being locked at the enclosure. Finally, secure chain with a its padlock.

General note:



Do not use the alignment plane of the enclosure for mechanical adjustment, e.g. for locking.
There is risk of damage to the sensor.

Mounting of remote version

The sensor probe of the remote version is mounted with a compression fitting in the same way as the compact sensor.

A wall mounting bracket is provided for fastening the sensor enclosure.

Accessories

The accessories required for mounting and operation of the **SCHMIDT®** Flow Sensor **SS 20.700** are listed in Table 3 below.

Type / Art. no.	Drawing	Assembly
Connecting cable Standard with fixed length: 5 m 524921		<ul style="list-style-type: none"> - Threaded ring, knurl - Plug injection-moulded - Material: Brass, nickel-plated PUR, PVC
Connecting cable ¹⁰ Standard with optional length: x m 524942		<ul style="list-style-type: none"> - Threaded ring, knurl - Material: Brass, nickel-plated Polyamide, PUR, PP Halogen-free¹¹
Coupler socket With thread locking 524929		<ul style="list-style-type: none"> - Threaded ring, knurl - Material: Brass, nickel-plated Polyamide, PUR, PP - Connection of wires: Screwed (0.25 mm²)
Sleeve ¹² a.) 524916 b.) 524882		<ul style="list-style-type: none"> - Internal thread G½, R½ - Material: a.) Steel, black b.) Stainless steel 1.4571

Table 3 Accessories

Informations about further accessories for mounting and display are available on the **SCHMIDT®** homepage:

www.schmidt-sensors.com

OR

www.schmidttechnology.de

¹⁰ Shielded, but shield not connected to cable socket.

¹¹ According to IEC 60754

¹² According to EN 10241; must be welded.

4 Electrical connection

The flow sensor **SS 20.700** has two connectors:

- Main connector:
 - Connection of voltage supply
 - Output of measuring signals
- Module connector:
 - For connection of an optional extension module.

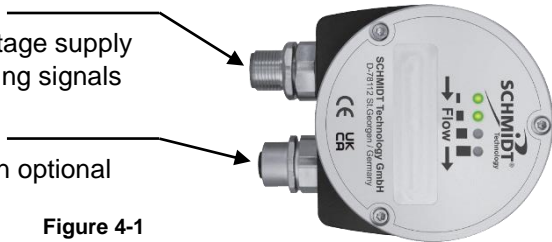

Figure 4-1

Main connector

The sensor is operated via this connector (pin assignment see Table 4).

Number of connection pins:	8 (plus shield connection at the metallic enclosure)
Type:	M12, A-coded, male
Fixation of connecting cable:	M12 thread (spigot nut at connecting cable)
Type of protection:	IP67 (with screwed cable)
Model:	Binder, series 763
Pin numbering:	



View on connector of sensor

Figure 4-2

Pin	Name	Function	Wire color
1	Pulse 1	Output signal: Flow / volume (digital: PNP)	White
2	U _B	Operating voltage: +24 V _{DC} ± 20 %	Brown
3	Analog T _M	Output signal: Temperature of medium (Auto-U/I)	Green
4	Analog w _N	Output signal: Flow velocity (Auto-U/I)	Yellow
5	AGND	Reference potential for analog outputs	Gray
6	Pulse 2	Output signal: Flow / volume (digital: relay ¹³)	Pink
7	GND	Operating voltage: Ground	Blue
8	Pulse 2	Output signal: Flow / volume (digital: relay ¹³)	Red
	Shield ¹⁴	Electromechanical shielding	Meshwork

Table 4

The specified wire colors are valid when one of the **SCHMIDT**[®] connecting cables is used (see subchapter *Accessories*, Table 3).

¹³ Galvanically decoupled

¹⁴ For cable with mat. no. 524942, the shield is not connected to the cable socket.

The analog signals have an own AGND reference potential.



Make sure that no supply voltage is active during electrical installation and that it cannot be switched on inadvertently.

The metal sensor enclosure is indirectly coupled to GND (with a varistor¹⁵, parallel to 100 nF) and should be connected to a protective potential, e.g. PE (depending on the shielding concept).



The appropriate protection class III (SELV) respective PELV (according EN 50178) has to be considered.

Module connector

The module connector (M12, A-coded, female, 5-pin; see Figure 4-1) is used to connect additional, optional expansion modules.



Only expansion modules from **SCHMIDT Technology** may be connected to the module connector.

Operating voltage

The flow sensor **SS 20.700** is protected against reverse polarity of the operating voltage. For its intended operation, it requires a DC voltage of 24 V_{DC} with a tolerance of $\pm 20\%$.



Operate the sensor only within the specified voltage range of 24 V_{DC} $\pm 20\%$.

Undervoltage may result in malfunction; overvoltage may lead to irreversible damage.

Specifications of supply voltage apply to the connector of the sensor. Voltage drops generated due to line resistances must be taken into account by the customer.

The operating current of the sensor (analog signal currents included, without any of the pulse outputs) is normally approx. 80 mA. With pulse output¹⁶, the required current value increases to max. 200 mA¹⁷.

Wiring of analog outputs

Both analog outputs for flow and temperature are designed as high-side driver with "Auto-U/I" feature and are permanently short-circuit protected against both rails of the operating voltage.

¹⁵ Voltage-dependent resistor (VDR); breakthrough voltage 30 V @ 1 mA

¹⁶ Without signal current of the semiconductor relay

¹⁷ Both signal outputs with 22 mA (maximum measurement values); supply voltage minimal

- Use of only one analog output

It is recommended to connect the same resistance value to both analog outputs, even if only one of them is used. For example, if only the analog output “flow velocity” is operated as current output with a load of a few ohms, it is recommended to connect the other analog output (“medium temperature”) with the same resistance value or directly to AGND.

- Nominal operation

The measuring resistance R_L must be connected between the corresponding signal output and the electronic reference potential of the sensor (see Figure 4-3). Typically, AGND must be selected as measuring reference potential for the signal output. The supply line GND can also be used as reference potential, however, the ground offset can cause significant measurement errors in the “Voltage” operating mode.



AGND should generally be selected as reference potential for the analog signal outputs.

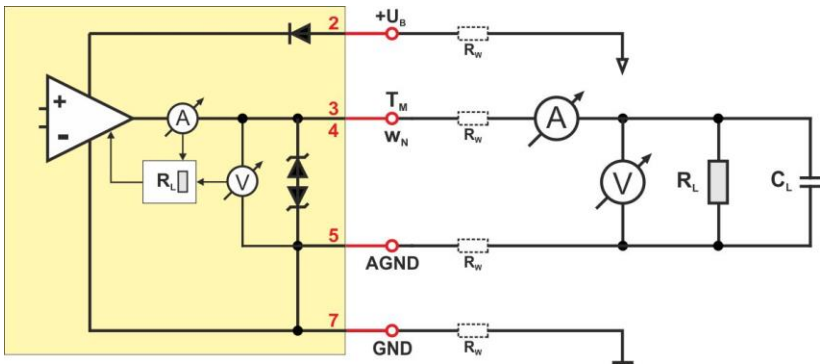

Figure 4-3

Depending on the load resistance R_L , the signal electronics switches automatically between its operation as voltage interface (mode: “U”) or current interface (mode: “I”), hence the designation “Auto-U/I”.

The switching threshold is in the range between 500 ... 550 Ω (for details refer to *chapter 5 Signaling*). However, in voltage mode a low resistance value may cause significant voltage losses via the line resistances R_W of the connection cable which can lead to measuring errors.



For voltage mode, a measuring resistance of at least 10 k Ω is recommended.

The maximum load capacitance C_L is 10 nF.

- Short circuit mode

In case of a short circuit against the positive rail of the supply voltage (+U_B), the signal output is switched off.

In case of a short circuit against the negative rail (GND) of the operating voltage, the output switches to the current mode (R_L is calculated to 0 Ω) and provides the corresponding signal current.

If the signal output is connected to +U_B via a resistance, the value R_L is calculated incorrectly and false signal values are caused.

Wiring of pulse output 1 (highside driver, PNP)

The pulse output is current-limited, short-circuit protected and has the following technical characteristics:

Design:	Highside driver, open collector (PNP)
Minimum high level U _{S,H,min} :	U _B – 3 V (with maximum switching current)
Maximum low level U _{S,L,max} :	0 V
Short circuit current limitation:	Approx. 100 mA
Maximum leakage current I _{Off,max} :	10 μA
Minimum load resistance R _{L,min} :	Depending on switching voltage U _B (see below)
Maximum load capacitance C _L :	10 nF
Maximum cable length:	100 m
Wiring:	

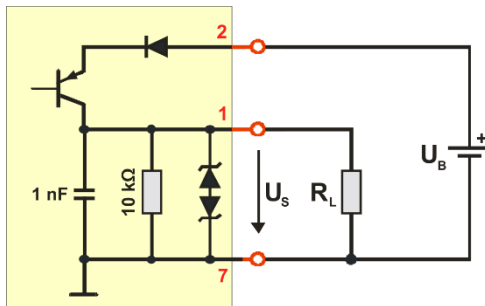

Figure 4-4

This pulse output can be used for direct driving of low-impedance loads (e.g. optocoupler, coil of relay etc.) with a maximum current consumption of approx. I_{L,max} = 100 mA.

This allows calculating the minimum permitted (static¹⁸) load resistance R_{L,min} depending on the operating voltage U_B:

$$R_{L,min} = \frac{U_B - 3 V}{I_{L,max}} = \frac{U_B - 3 V}{0.1 A}$$

Example:

In case of the maximum operating voltage of U_{B,max} = 28.8 V the minimal load is R_{L,min} = 258 Ω.

Here the excessive heating power of the load has to be considered.

¹⁸ Overcurrent peaks are absorbed by the short circuit limiter.

This pulse output is protected by means of different mechanisms:

- Current limiting:

The current is limited to approx. 100 mA (analog).

If the resistance value is too low, the length of the interconnection phases are limited to 100 μ s (period duration: 1 s).

The maximum load capacitance C_L is 10 nF. A higher capacitance reduces the limit of the current limiter.



In case of a high capacitive load C_L , the inrush current peak may trigger the quick-reacting short-circuit protection (permanently) although the static current requirement is below the maximum current $I_{S,max}$. An additional resistor connected in series to C_L can eliminate the problem.

- Protection against overvoltage.

The pulse output is protected against short-term overvoltage peaks (e.g. due to ESD or surge) of both polarities by means of a TVS diode¹⁹. Long-term overvoltage destroys the electronics.



Overvoltage can destroy the pulse output.

Wiring of pulse output 2 (relay)

This output is realized by a semiconductor relay (SSR):

Maximum leakage current $I_{Off,max}$:	2 μ A
Maximum resistance R_{ON} :	16 Ω (typ. 8 Ω)
Maximum switching current I_S :	50 mA
Maximum switching voltage U_S :	30 V _{DC} / 21 V _{AC,eff}

Wiring:

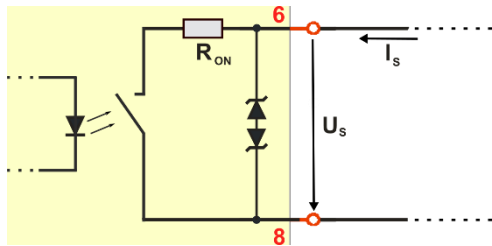

Figure 4-5

The relay output is only protected against short-term overvoltage peaks (e.g. due to ESD or surge) of both polarities by means of a TVS diode.



The output has no protective measures, exceeding the specified electrical operating values leads to irreversible damage.

¹⁹ Transient Voltage Suppressor Diode, breakdown voltage approx. 30 V

5 Signaling

LED bar (enclosure cover)

The **SCHMIDT® Flow Sensor SS 20.700** has four Duo-LEDs²⁰ (see Figure 5-1) in the enclosure cover. They either indicate the flow velocity in fault-free operation in a quantitative way (bar graph mode) or they signal the cause of a problem (see Table 5).

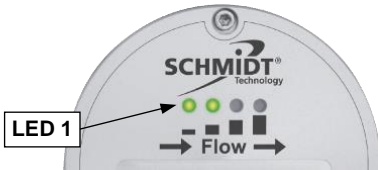

Figure 5-1

No.	State	LED 1	LED 2	LED 3	LED 4
1	Ready for operation & flow < 5 % ²¹	Orange	Off	Off	Off
2	Flow > 5 %	Green	Off	Off	Off
3	Flow > 20 %	Green	Green	Off	Off
4	Flow > 50 %	Green	Green	Green	Off
5	Flow > 80 %	Green	Green	Green	Green
6	Flow > 100 % = overflow	Green	Green	Green	Orange
7	Sensor element defective	Flashes Red	Flashes Red	Flashes Red	Flashes Red
8	Operating voltage too low	Flashes Red	Flashes Red	Off	Off
9	Operating voltage too high	Off	Off	Flashes Red	Flashes Red
10	Electronic temperature too low	Off	Flashes Red	Flashes Red	Off
11	Electronic temperature too high	Flashes Red	Off	Off	Flashes Red
12	Medium temperature too low	Orange	Flashes Red	Flashes Red	Orange
13	Medium temperature too high	Flashes Red	Orange	Orange	Flashes Red

Table 5

○ LED off

● LED on: Green

● LED on: Orange

◐ LED flashes²²: Red

²⁰ Component with two integrated LEDs (red and green).

²¹ „%“ of measurement range

²² Approx. 1 Hz

LED (light) ring

The light ring encircling the enclosure serves as an additional signaling, which depends on whether and if so, which module is connected.

➤ Flow sensor without auxiliary module

In this case, the light ring signals the operating status of the **SS 20.700**, supplementary to the Duo-LED strip in the cover of the enclosure:

- Ring lights green: Sensor is in operation
- Ring flashes orange: Operational parameter violated
 - Supply voltage
 - Temperature of electronics
 - Temperature of medium
- Ring flashes red: Sensor is defective

➤ Flow sensor with connected auxiliary module



The operating status of the **SS 20.700** has signal priority, i.e. if a problem occurs in the sensor, it will be indicated like written above.

If the **SS 20.700** is fully operational, the light ring indicates the status of communication between sensor and module according to Table 6.

Light ring signalization	Status of module / communication	Module
Blue rotating (2 R/s), 5 x	Contacting Sensor - module: In Progress	Bluetooth
Blue O/I alternating flashing (2 Hz)	Communication sensor - module: Active	
Blue simultaneous flashing (1 Hz)	Communication sensor - module: Frozen	
Orange rotating (2 R/s), 5 x	Contacting Sensor - module: In Progress	MD 10.020
Orange O/I alternating flashing (2 Hz)	Communication sensor - module: Active	
Orange simultaneous flashing (1 Hz)	Communication sensor - module: Frozen	
Orange rotating (2 R/s), 5 x	Contacting Sensor - module: In Progress	Prog-Kit
Orange ring simultaneous lighting & O/I alternating flashing (2 Hz)	Communication sensor - module: Active	
Orange simultaneous flashing (1 Hz)	Communication sensor - module: Frozen	
Orange rotating (2 R/s), 5 x	Contacting Sensor - module: In Progress	Data logger
Orange ring simultaneous lighting & O/I alternating flashing (2 Hz)	Communication sensor - module: Active	
Orange ring simultaneous lighting & Periodic moving light (1 Hz): 	Erasing log memory: In progress	
Orange simultaneous flashing (1 Hz)	Communication sensor - module: Frozen	

Table 6

- „Rotating“: Clockwise rotation (view on enclosure cover)
- „R/s“: Revolutions (= completed rotations) per second
- „O1“, „O2“, „I1“, „I2“: LEDs near both connectors („O“: outside; „I“: inside, see Figure 5-2)
- „O/I alternating flashing“: LED-pairs „O1 + O2“ and „I1 + I2“ flashing alternately

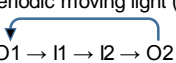
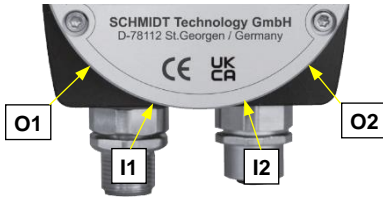

Figure 5-2 Position of LEDs for alternating flashing or moving light

Analog outputs

- Switching characteristic Auto-U/I

Interval of load value R_L	Signaling mode	Signaling range
≤ 500 (550) Ω	Current (I)	4 ... 20 mA
> 500 (550) Ω	Voltage (U)	0 ... 10 V

Table 7

A hysteresis of approx. 50 Ω ensures a stable transition behavior (see Figure 5-3).

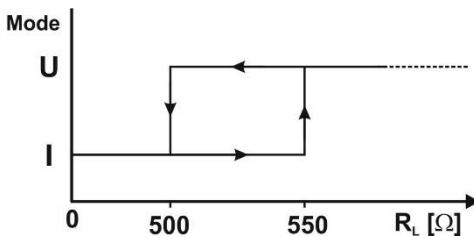

Figure 5-3

Depending on the provided output signal characteristic the accuracy of detection of the switching point can be reduced. Therefore, it is recommended to select the load resistance such that a safe detection can be maintained ($\leq 300 \Omega$ for current mode and $\geq 10 \text{ k}\Omega$ for voltage mode). To detect possible alternating load in an actual zero signal (voltage mode), the electronics generates test pulses that correspond to an effective value of approx. 1 mV. However, the latest measuring devices may trigger in response to such a pulse in DC voltage measuring mode and display short-term measuring values of up to 20 mV. In this case, it is recommended to install an RC filter at the measuring input with a time constant of 20 ... 100 ms.

- Error signaling
In current mode, the interface outputs 2 mA²³.
In voltage mode, the output switches to 0 V.

²³ In accordance with the Namur specification.

- Representation of measuring range

The measuring range of the corresponding measuring value is mapped in a linear way to the mode-specific signal range of the associated analog output.

For flow velocity, the measuring range ranges from zero to the selectable end of the measuring range $w_{N,max}$ (see Table 8).

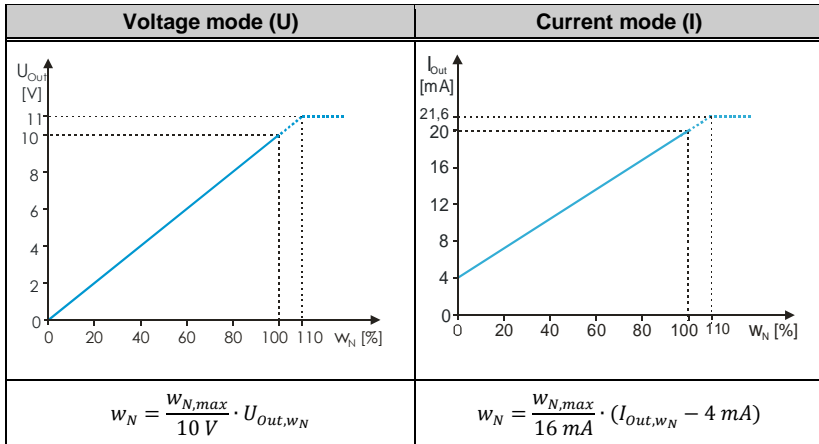

Table 8 Representation specification for flow velocity measurement

The measuring range of medium temperature starts at $T_{Min} = -20\text{ °C}$ and ends at $+120\text{ °C}$ (see Table 9).

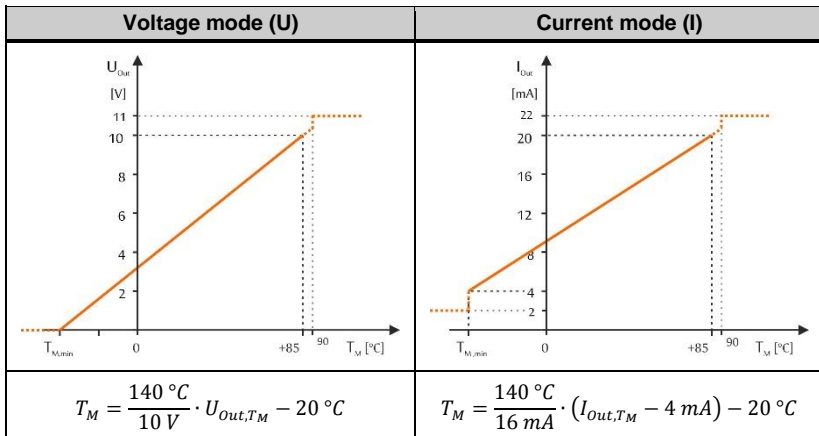

Table 9 Representation specification for measurement of medium temperature

- Exceeding measuring range of flow velocity w_N
 Measuring values larger than $w_{N,max}$ are output in a linear way up to 110 % of the signaling range (this corresponds to 11 V resp. 21.6 mA, see graphics in Table 8). At higher values of w_N , the output signal remains constant.
 Error signaling does not take place because damaging of the sensor is unlikely.
- Medium temperature T_M outside specification range
 Operation beyond the specified limits can damage the sensor and, therefore, is seen as a critical error. This leads to the following reaction depending on the temperature limit (also refer to graphics in Table 9):
 - Medium temperature below $T_{M,min} = -20\text{ °C}$:
 The analog output for T_M switches to error (0 V or 2 mA)²⁴.
 The measuring function for flow velocity is switched off, its analog output also signals an error (0 V resp. 2 mA).
 - Medium temperature above $T_{M,max} = +120\text{ °C}$:
 T_M is output in a linear way up to at least +125 °C, flow velocity is measured and displayed further on.
 Above this critical limit, flow measurement is switched off and the analog output w_N switches to error signaling (0 V or 2 mA).
 The signal output for T_M , on the other hand, jumps to the maximum values of 11 V resp. 22 mA, in contrast to normal error signaling.
 This is to avoid a catastrophic feedback if a heating control uses the medium temperature sensor of the **SS 20.700**. The standard error signal (0 V or 2 mA) could be interpreted by the control as a very low temperature of the medium which would consequently lead to further heating.

²⁴ The switching hysteresis for the threshold is approx. 5 K.

Pulse outputs

The pulse outputs represent the flow velocity w_N as an alternative to the analog output.

- The basic version of the **SS 20.700** maps the flow velocity w_N proportional to a frequency range $[0 \dots f_{\max}]$ with selectable maximum frequency f_{\max} (see Figure 5-4).

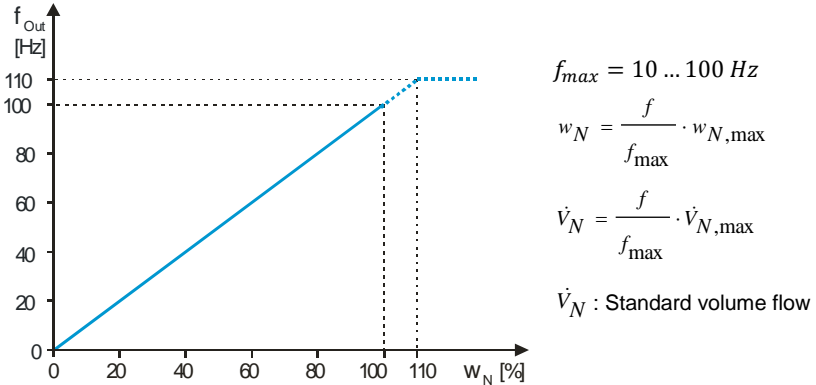

Figure 5-4 Example for $f_{\max} = 100 \text{ Hz}$

The volume flow \dot{V}_N and the pulse valence $V_{N,\text{Imp}}$ (= volume per pulse) can be determined on base of the actual output frequency, the measuring range $w_{N,\max}$ of the sensor and the inner pipe diameter D :

$$\dot{V}_N = w_N \cdot PF \cdot A_D = w_N \cdot PF \cdot \frac{\pi}{4} \cdot D^2; \quad V_{N,\text{Imp}} = \frac{\dot{V}_{N,\max}}{f_{\max}}$$

Exceeding the measuring range is also output linearly up to 110 % of the measuring range. Higher values of flow velocity or volume flow are limited to 110 % of the measuring range.

- Optional the sensor can be configured by ordering to supply pulses with a predefined pulse valency (e.g. 1 m³/pulse).

For this, the inner pipe diameter must be specified when ordering (at minimum DN40).

If an error occurs, $f = 0 \text{ Hz}$ resp. no pulses will be output. The current signal level remains unchanged.

Note:

The relay can be used as a S0-Interface²⁵ according EN 62053-31.

²⁵ Former standard: DIN 43 864

6 Commissioning

Prior to switching on the **SCHMIDT® Flow Sensor SS 20.700**, the following checks have to be carried out:

- Mechanical installation:
 - Correct immersion depth and alignment of the sensor probe according to flow direction
 - Tightening of fastening screw or spigot nut
 - Installation of pressure safety measures



For measurements in media with overpressure, check if the fastening screw is tightened properly and pressure safety devices are installed.

- Connecting cable:
 - Correct connection in the field (switch cabinet or similar)
 - Tightness of sensor connector and connecting cable (flat seal must be inserted correctly into the female cable connector)
 - Tight fit of spigot nut of cable connector at the sensor enclosure

After switching on the supply voltage, the sensor signals its initialization by switching all four LEDs in the enclosure cover sequentially to red, orange and green.

If the sensor detects a problem during initialization, it signals the problem with the cover LEDs according to Table 5. An extensive overview of possible errors, their causes as well as troubleshooting measures are listed in Table 10. In addition the ring LEDs shows

- Complete lights green: sensor is fully operational
- Complete ring flashes red: sensor is defective

If the sensor is operating as intended after the initialisation, it switches into regular measuring mode. For a short period the flow velocity indication (both LED strip and signal outputs) goes to maximum and settles to the correct measuring value after about 10 seconds, provided the sensor probe was already at medium temperature. Otherwise, the process will last longer until the sensor has reached the medium temperature.

7 Information concerning operation

Environmental condition Temperature

The **SCHMIDT® Flow Sensor SS 20.700** monitors both the medium and the electronics temperature. As soon as one of the specified operating ranges is left, the sensor switches off both measuring functions associated with the medium and signals this error via the LED strip (according to Table 5) as via the light ring.

As soon as proper operational conditions are restored, the sensor resumes measuring mode.



Even short-term exceeding or undershooting the operating temperatures can cause irreversible damage to the sensor.

Environmental conditions of medium

The **SCHMIDT® Flow Sensor SS 20.700** is also suitable for relatively impure gases. Dust or non-abrasive particles can be tolerated as long as they do not form any deposits on the sensor elements.

Deposits or other soiling must be detected during regular inspections and removed during cleaning because they can lead to distortion of the measurement result (see chapter 8 *Service information*).



Dirt or other deposits on the sensor elements may cause false measurement results.

Therefore, the sensor must be checked for contamination at regular intervals and cleaned if necessary.

Condensing liquids or even immersion in a liquid lead to a strong falsification of the measured values. After drying, correct measured values are provided again.



Always avoid liquids on the sensor during operation because it leads to serious measurement distortions.

8 Service information

Maintenance and cleaning of sensor head

Heavy soiling of the sensor elements may lead to measurement distortion. The sensor head can be cleaned carefully if it is soiled or dusty.



The sensor head is a sensitive measuring system. During manual cleaning proceed with great care.

Eliminating malfunctions

The following Table 10 lists possible errors (images), depicted by the LED bar. A description of the way to detect errors is given. Furthermore, possible causes and measures to be taken to eliminate errors are listed.



The cause of any error signal must be remedied immediately. Significantly exceeding or falling below the permitted operating parameters can permanently damage the sensor.







Error image	Possible causes	Troubleshooting
 <p>No LED is lit All signal outputs at zero</p>	<p>Problems with supply voltage U_B:</p> <ul style="list-style-type: none"> ➢ No U_B present ➢ U_B has wrong polarity ➢ $U_B < 15\text{ V}$ <p>Sensor defective</p>	<ul style="list-style-type: none"> ➢ Is cable connector screwed on correctly? ➢ Is supply voltage connected to the control? ➢ Is voltage at the sensor plug (cable break)? ➢ Is power supply unit large enough?
<p>Start sequence is repeated continuously (all LEDs red - yellow - green)</p>	<p>U_B unstable:</p> <ul style="list-style-type: none"> ➢ Power supply unit unable to supply switch-on current ➢ Other consumers overload U_B ➢ Cable resistance too high 	<ul style="list-style-type: none"> ➢ Is supply voltage at sensor stable? ➢ Is power supply unit large enough? ➢ Are voltage losses over cable negligible?
	Sensor element defective	Return sensor for repair
	Supply voltage too low	Increase supply voltage
	Supply voltage too high	Reduce supply voltage
	Electronic temperature too low	Increase temperature of environment
	Electronic temperature too high	Lower temperature of environment
	Medium temperature too low	Increase medium temperature
	Medium temperature too high	Lower medium temperature
<p>Flow signal w_N is too large / small</p>	<p>Measuring range too small / large</p> <p>I-mode instead of U-mode or vice versa</p> <p>Medium to be measured does not correspond to adjustment medium</p> <p>Sensor element soiled</p>	<p>Check sensor configuration</p> <p>Check type or measuring resistance</p> <p>Is foreign gas correction considered?</p> <p>Clean sensor head</p>
<p>Flow signal w_N is fluctuating</p>	<p>U_B unstable</p> <p>Mounting conditions:</p> <ul style="list-style-type: none"> ➢ Sensor head is not in optimum position ➢ Inlet or outlet is too short <p>Strong fluctuations of pressure or temperature</p>	<p>Check voltage supply</p> <p>Check mounting conditions</p> <p>Check operating parameters</p>
<p>Analog signal voltage permanently at maximum</p>	Load resistance of signal output connected to $+U_B$	Connect load resistance to AGND
<p>Analog signal voltage permanently at zero</p>	<p>Error signaling</p> <p>Short circuit against (A)GND</p>	<p>Eliminate errors</p> <p>Eliminate short circuit</p>

Table 10

Transport / Shipment of the sensor

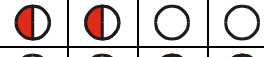
Before transport or shipment of the sensor, the delivered protective cap must be placed onto the sensor head. Avoid contaminations or mechanical stress.

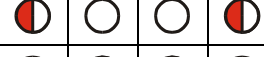
Calibration

If the customer has made no other provisions, we recommend repeating the calibration at a 12-month interval. To do so, the sensor must be sent in to the manufacturer.

Spare parts or repair

No spare parts are available, since a repair is only possible at the manufacturer's facilities. In case of defects, the sensors must be sent in to the supplier for repair.

- **A completed declaration of decontamination must be attached.**

The appropriate form "Declaration of decontamination" is enclosed with the sensor and can also be downloaded from

www.schmidt-sensors.com

under the heading "Service & Support for Sensors".

Alternatively it can be downloaded from

www.schmidttechnology.de

under the heading "Service & Support für Sensorik".

If the sensor is used in systems important for operation, we recommend you to keep a replacement sensor in stock.

Test certificates and material certificates

Every new sensor is accompanied by a certificate of compliance according to EN 10204-2.1. Material certificates are not available.

Upon request, we shall prepare, at a charge, a factory calibration certificate, traceable to national standards.

9 Dimensions

Compact sensor

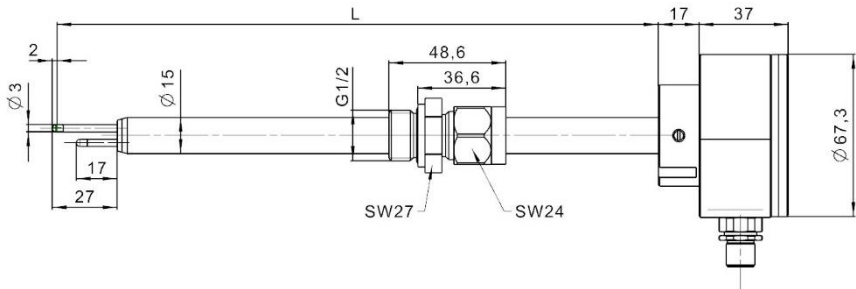

Figure 9-1

Remote sensor (including wall mounting bracket)

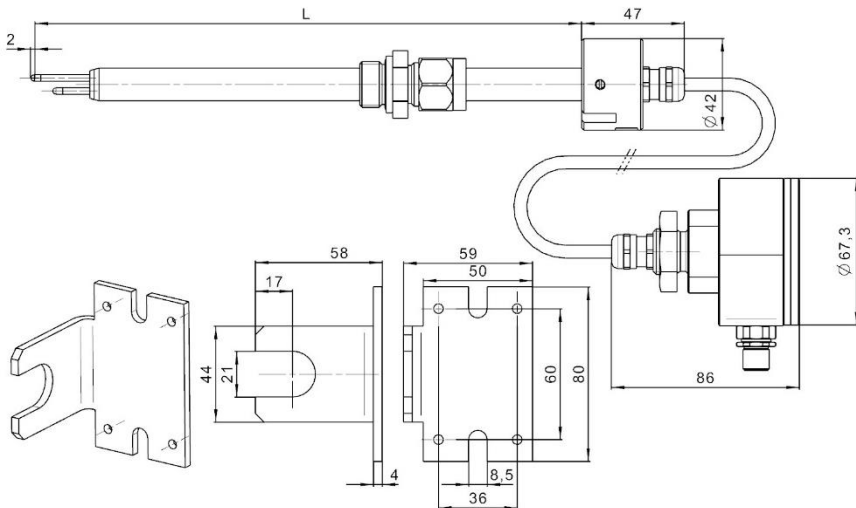

Figure 9-2

10 Technical data

Measurement-specific data	
Measuring values	Standard velocity w_N of air, based on standard conditions of 20 °C and 1,013.25 hPa Temperature of medium T_M
Medium to be measured	Standard: Air or nitrogen Optional: Natural gas, biogas, CO ₂ and special gases or gas mixtures
Measuring range w_N	Standard: 0 ... 10 / 20 / 60 / 90 / 140 / 220 m/s Special: 10 ... 220 m/s (steps: 1 m/s)
Lower detection limit w_N	0.1 m/s
Measuring range T_M	-20 ... +120 °C
Measuring accuracy²⁶	
Standard w_N	$\pm 3\%$ o. m. v. + (0.4 % o. f. v.; min. 0.08 m/s) ²⁷
Response time (t_{90}) w_N	10 s (jump of w_N from 0 to 5 m/s in air)
Temperature gradient w_N	< 8 K/min (at $w_N = 5$ m/s)
Measuring accuracy ²⁸ T_M	± 1 K (10 ... 30 °C) ± 2 K remaining measuring range
Operating temperature	
Sensor probe	-20 ... +120 °C
Electronics	-20 ... +70 °C
Storage temperature	-20 ... +85 °C
Material	
Enclosure	Anodized aluminum
Sensor tube	Stainless steel 1.4571
Compression fitting	Stainless steel 1.4571, NBR (or FKM)
Sensor head	Stainless steel 1.4404
Sensor cable (remote sensor)	Sheathing TPE, halogen-free

²⁶ Under reference conditions

²⁷ „o. m. v.“: of measured value; „o. f. v.“: of final value

²⁸ ($w_N > 2$ m/s)

General data	
Humidity range	Measuring mode: Non-condensing (< 95 % RH)
Operating overpressure (max.)	16 bar
Display	Stripe of 4 dual LEDs (green / red / orange) LED ring
Supply voltage U_B	24 V _{DC} ± 20 %
Current consumption	Approx. 80 mA (without pulse outputs); max. 200 mA ²⁹
Analog outputs - Type: Auto U / I Switching Auto-U/I - Voltage output - Current output - Switching hysteresis Maximum load capacitance	Flow velocity, temperature of medium Automatic switching signal mode based on load R_L 0 ... 10 V for $R_L \geq 550 \Omega$ 4 ... 20 mA for $R_L \leq 500 \Omega$ 50 Ω 10 nF
Pulse outputs - Signaling: - Pulse output 1: - Pulse output 2:	$f \sim w_N$: 0 m/s ... $w_{N,max} \rightarrow 0 \text{ Hz} \dots f_{max}$ Standard: $f_{max} = 100 \text{ Hz}$ Option : $f_{max} = 10 \dots 99 \text{ Hz}$ Option: 1 pulse / 1 m ³ 1 pulse / 0.1 m ³ 1 pulse / 0.01 m ³ (max. 100 Hz) High-side driver connected to U_B (without galvanic separation) High level: > $U_B - 3 \text{ V}$ Short circuit current limitation: 100 mA Leakage current: $I_{off} < 10 \mu\text{A}$ Semiconductor relay (output galvanically separated) Max. 30 V _{DC} / 21 V _{AC,eff} / 50 mA
Electrical connection	Main connector: M12, A-coded, male, 8-pin Module connector: M12, A-coded, female, 5-pin
Maximum cable length	Voltage signal: 15 m, current signal / pulse: 100 m
Installation position	Arbitrary
Direction / mounting tolerance	Unidirectional / ±3° relative to flow direction
Minimum immersion depth	DN40
Type of protection	IP66 (enclosure), IP67 (sensor probe)
Protection class	III (SELV) or PELV (according EN 50178)
Probe length - Compact sensor - Remote sensor	Standard: 250 / 600 mm Probe: 250 / 600 mm Cable: 1 ... 10 m (steps: 1 m)
Weight	Approx. 500 g max. (without connecting cable)

²⁹ Without signal current of pulse output 2 (relay)

11 Declarations of conformity

SCHMIDT Technology GmbH herewith declares in its sole responsibility, that the product

SCHMIDT® Flow Sensor SS 20.700

Part-No. **562 140**

is in compliance with the appropriate



European guidelines and standards

and



UK statutory requirements and designated standards.

The corresponding declarations of conformity can be download from **SCHMIDT®** homepage:

www.schmidt-sensors.com

www.schmidttechnology.de



SCHMIDT Technology GmbH

Feldbergstr. 1
78112 St. Georgen
Germany

Phone +49 (0)7724 / 899-0

Fax +49 (0)7724 / 899-101

Email sensors@schmidttechnology.de

URL www.schmidt-sensors.com
www.schmidttechnology.de