

# USER MANUAL

---

## CEL-712 Microdust Pro Real Time Dust Monitor

*HB4048-02*

*May 2021*

Casella  
Regent House,  
Wolseley Road,  
Kempston,  
Bedford.  
MK42 7JY  
T:+44(0) 1234 844 100  
F:+44(0) 1234 841 490  
E: [info@casellasolutions.com](mailto:info@casellasolutions.com)

---

[www.casellasolutions.com](http://www.casellasolutions.com)

CASELLA

# Contents

1	Introduction.....	4
1.2	Safety.....	6
2	Features and description .....	8
2.1	Principle of operation .....	9
2.2	Display screen groups .....	9
2.3	Connections.....	11
3	Quick reference .....	13
3.1	Providing power for the instrument .....	13
3.2	How to fit the measurement probe .....	15
3.3	Using the controls.....	16
3.4	How to follow the operating instructions .....	17
3.5	Switch-on.....	17
3.6	Set the instrument’s display language .....	20
3.7	Set the time and date .....	21
3.8	Setup .....	22
3.9	Set the display backlight .....	23
3.10	Alarm and analogue output settings.....	25
3.11	Checking the instruments Zero and Span.....	27
3.12	Calibration for specific particulate types - Gravimetric calibration ..	33
4	Making a measurement run.....	37
4.1	Measurement types.....	38
4.2	Starting a measurement Run .....	38
4.3	Viewing stored Runs .....	41
4.4	Deleting stored Runs .....	42
5	USB connection.....	43
6	Insight data management software .....	44
6.1	Installing and starting the Insight Data Management Software .....	45
7	Sampling accessories .....	46

---

7.1	Sampling Adapters (PUF Size Selective and Gravimetric TSP) .....	46
8	Specifications .....	50
8.1	Instrument specification .....	50
8.2	Displayed values .....	52
8.3	Data logging.....	52
8.4	Optional accessories .....	53
8.5	Standards compliance.....	54
9	Maintenance and servicing .....	55
9.1	Lens contamination .....	55
9.2	General maintenance .....	56
9.3	Servicing hints.....	57
10	Servicing and warranty arrangements .....	58
10.1	Inspection and test .....	58
10.2	User servicing .....	58
	Appendix – serial communication interface .....	59
	Command set for remote control.....	59

# 1 Introduction

The CEL-712 Microdust Pro is a real-time dust monitoring instrument ideally suited for the measurement of particulate concentration such as from dust, smoke, fumes, pollen and other aerosols from combustion, materials processing, manufacturing, energy generation, vehicle engine emissions, and construction. Pollutants of this type reduce visibility, spread contamination and can cause illness and low worker productivity from the inhalation of toxic substances. Many of them are also recognised as contributory factors to many chronic and acute medical conditions, including asthma, bronchitis, and lung cancer.

The Microdust Pro instrument is not like traditional gravimetric methods of dust measurement, which require a significant sampling period and are not suited to the real-time evaluation of trends in concentration levels. The Microdust Pro is an ideal survey instrument for the assessment of real-time particulate concentration in  $\text{mg}/\text{m}^3$ . It is totally portable and has a detachable probe that allows operation in relatively inaccessible areas, making it suitable both for fixed site and for general survey applications.

The Microdust Pro instrument uses a proven forward light scattering principle to make accurate and repeatable measurements of dust concentration. It provides the following features as standard:





- Graphical representation of concentration trends
- Internal data logging
- A simple and clear colour user interface
- Wide measurement concentration capability to suit a vast range of dust monitoring applications.

The Microdust Pro instrument allows you to download data to the Casella Insight Data Management Software. This application provides a real-time display of particulate concentration levels measured by the instrument. Refer to the on-line help system installed with the Casella Insight Data Management Software for full instructions on how to use this application.

The Apex2 does not present a safety risk when you use it as instructed in this User Manual. However, it is possible that the environment where you use the instrument may present a safety risk. For this reason, always follow correct, safe working practices.

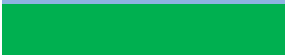
### Colour coding

The Microdust Pro screens use a colour code to help you identify their purpose quickly. This manual uses the same colour codes. Refer to section 2.2 Display screen groups beginning on page 9 for more information.

<i>This colour...</i>		<i>indicates...</i>
Light Blue		Memory results screens
Green		Measurement Run screens
Red		Measurement stop screens
Yellow		Calibration mode
Blue		Menu screens

## 1.2 Safety

The Microdust Pro instrument does not present a safety risk when you use it as instructed in this User Manual. However, it is possible that the environment where you use the instrument may present a safety risk, and you must **ALWAYS follow correct, safe working practices.**



### WARNING – CLASS 1 LASER PRODUCT

The Microdust Pro instrument is an enclosed Laser based system.

The internal laser radiation is the equivalent of Class 2 under normal conditions and potentially 3B under fault conditions.

Laser Source <20mW @ 638 nm.

Caution – use of controls or adjustments or performance of procedures other than those specified herein may result in hazardous radiation exposure.

Risk of Visible Laser Radiation when opened. Avoid exposure to beam.

This product shall only be opened by authorised and competent personnel.

The following warning labels are displayed on this instrument:

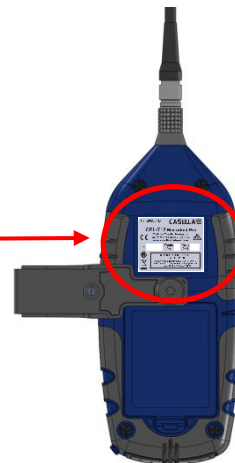
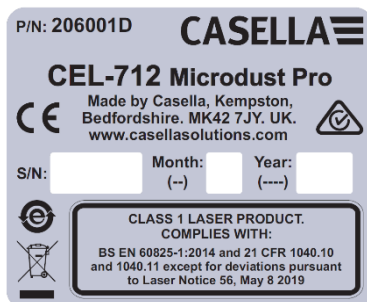

**WARNING – DO NOT USE IN VOLATILE OR EXPLOSIVE ATMOSPHERES**

Always be aware of the risks in the environment where you are working.

- The Microdust Pro instrument is NOT intrinsically safe. DO NOT use it in an atmosphere where explosive concentrations of vapours or dusts might exist.
- Wear approved ear defenders when making measurements in noisy environments.
- Wear approved protective clothing and footwear suitable for the environment where you are making measurements.
- Always follow local safety regulations and be aware of risks in the area where you are working.

**CAUTION - GENERAL**

Use the Microdust Pro instrument only as instructed in this User Manual. Do not use the instrument for any purposes for which it has not been designed.

The Microdust Pro is a precision instrument. Always handle it with care.

Do not use the Microdust Pro instrument if it has been damaged. Refer to section 10 Servicing and warranty arrangements beginning on page 58 for instructions to follow if the instrument has been damaged or has developed a fault.

The Microdust Pro instrument can operate from a battery power supply.

- Use only batteries of the correct type, and do not mix battery types in the instrument. Refer to
- Battery supply on page 13 for advice about battery types.
- Do not leave discharged batteries in the instrument.
- Install new batteries as a complete set. Do not fit batteries that have a mixed state of charge. Refer to How to fit new batteries on page 13 for instructions to install batteries.
- Remove all batteries from the Microdust Pro instrument if you will not use the instrument for a long time.

Always follow local regulations to dispose of used batteries.

The Microdust Pro instrument is not waterproof. Do not immerse the instrument in water or use it in the rain.

## 2 Features and description

Figure 1 shows the main features of the Microdust Pro instrument. Refer to these details to help you identify the relevant controls to use when you perform the tasks and instructions in this User Manual.

**Figure 1 Main features of the Microdust Pro instrument**

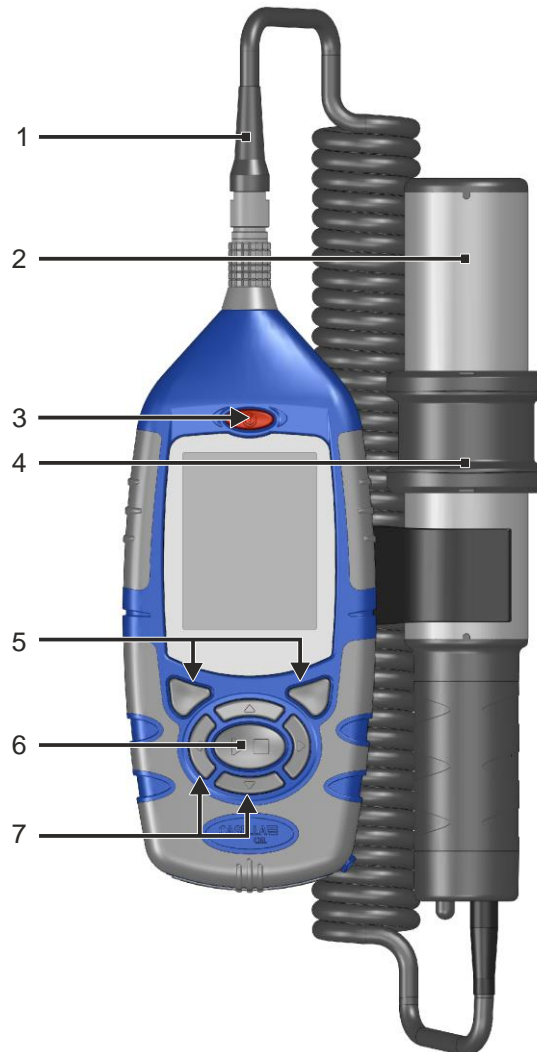

1. Probe connector and cable
2. Probe
3. ON/OFF key
4. Probe collar (covering the sampling hole)
5. Soft keys
6. Run/Stop key
7. Navigation keys

Refer to section 3.3 Using the controls on page 16 for a description of the Soft keys, of the Navigation keys, and of the Run/Stop key.



## 2.1 Principle of operation

The Microdust Pro instrument uses a modulated laser light source passing into a measurement chamber.

**Figure 2 Sampling probe**

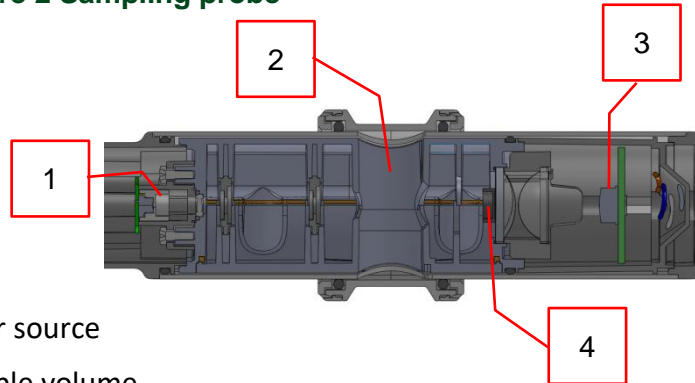

1. Laser source
2. Sample volume
3. Optical detector
4. Light stop

Under clean-air conditions, all light is prevented from following a direct route to reach the laser detector (3) by a light stop (4). When dust particles enter the sample volume (2), the beam of laser light is scattered within a narrow angle and some of it can reach the detector by indirect routes.

By using a narrow angle of scatter, the instrument is made less sensitive to variations in the refractive index and colour of measured particulate.

## 2.2 Display screen groups

The Microdust Pro instrument has groups of screens that allow you to set up and operate the instrument, and to see the results of the instrument's measurements. The screens have colour-coded bars at their top and bottom edges to help you identify which screen group they belong to. Refer to Colour coding on page 5. Figure 3 below also shows the colour codes together with the way the screen groups relate to each other.

Note that the contents of some screens may vary, depending on the variant of instrument you are using.

Figure 3 Screen groups

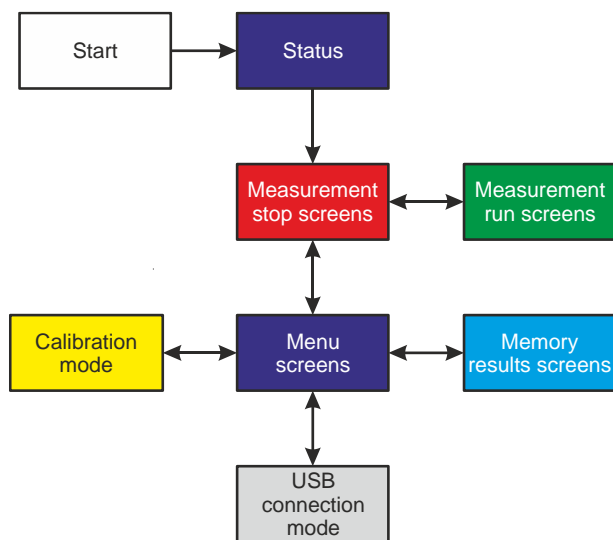

Each screen group includes one or more individual screens. The instructions included throughout this manual show examples of the individual screens.

## 2.3 Connections

All connections to the Microdust Pro instrument are made through three ports behind a hinged panel at the bottom of the instrument.

**Figure 4 Connection port**

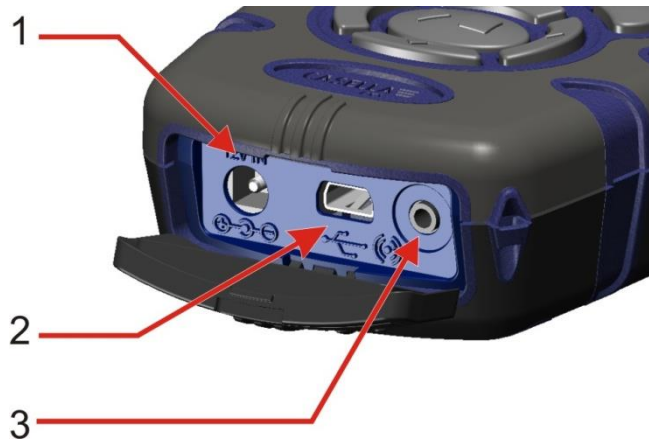

1. Power input port
2. Mini B USB port
3. 2.5mm output port

### Power input port

The power input port allows you to connect a DC power supply to operate the instrument. You must use a 2.1 mm DC plug that has the positive supply connected to the centre receptacle.

Refer to Mains DC supply on page 14 for information about the requirements of a suitable mains DC power supply for use with the Microdust Pro instrument.

### Mini B USB port

The Mini B USB port allows you to connect the Microdust Pro instrument to PC.

When you connect the instrument to a PC, the instrument appears as a removable disk drive in Windows Explorer.

The **Casella Insight Data Management Software** is supplied with the Microdust instrument. You must use this program to download measurements directly from the instrument without using Windows Explorer. The Insight software includes analysis and graphing tools, which you can use to analyse and view measurement Runs.

### 2.5 mm output port

The 2.5 mm output port is a 2.5 mm stereo jack. It has two functions:

- The tip connection (1) provides an analogue DC output signal. The output level is 2.5 VDC to represent the full-scale of the range currently selected.
- The ring connection (2) provides a switched open-drain Alarm output signal which may be used to control external alarms or monitoring devices. The output line is pulled low whenever the Alarm threshold level and trigger time is exceeded. It is cleared when the prevailing dust level fall below the defined 'Alarm Off' conditions.
- The maximum voltage and current should be <15 volts at <500 mADC.
- The output impedance for the DC output is approximately 500Ω.
- If you use the DC output, you should make certain the load impedance is as high as possible.
- The signal ground for the outputs is on the barrel connection (3).

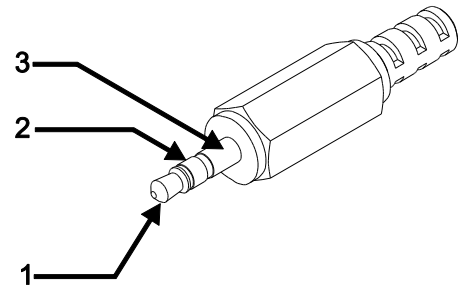

## 3 Quick reference

### 3.1 Providing power for the instrument

The options for providing power for the instrument are:

- Batteries
- 12 VDC adaptor (part number -PC18)
- USB connection (part number -CMC51)

#### Battery supply

You can use alkaline or rechargeable AA batteries to operate the instrument. Do not use a mixture of alkaline and rechargeable batteries at the same time.

The operating time that you can expect from a fully charged or new set of batteries depends on the battery capacity and whether you use the instrument's backlight. Environmental conditions such as the ambient temperature also affect battery life. Typical battery life based on Alkaline / NiMH (2700 mAh) is 13.5 hours at medium backlight level.

You should also carry a spare set of batteries.

**IMPORTANT:** To save power when operating on batteries, the Microdust Pro instrument switches OFF automatically if no measurement Run is in progress and there is no key-press activity for five minutes.

You should operate the instrument on a mains DC power supply if you must leave it unattended while making an extended measurement Run. The instrument does NOT switch off automatically when operating from a mains DC supply.

#### How to fit new batteries

Before you begin:

Read the caution notice about Batteries on page 7.

You should check that the batteries have adequate battery life before you begin a measurement. Replacement batteries should be new or fully charged.

Fitting the batteries

You do not need any special tools to fit new batteries to the instrument.

1. If necessary, press and hold the ON/OFF key to switch the instrument OFF.
2. Remove the three exhausted batteries from the battery compartment.
3. Fit fully charged batteries into the battery compartment, observing the polarity markings.
4. Press and release the ON/OFF key and check the battery symbol shows the batteries have a full charge level.

### Mains DC supply

The use of an external 12 VDC mains power supply enables the instrument to operate for extended measurement time periods.

The instrument will automatically switch ON whenever an external 12 VDC supply is connected.

The instrument DOES NOT include a mains DC supply as standard. Please use the optional Casella power supply (part number -PC18).

**NOTE:** The Microdust Pro instrument disconnects the internal batteries whenever a mains DC or USB power supply is applied. The batteries do not recharge when you operate the instrument from a DC supply.

If you use rechargeable batteries with the Microdust Pro instrument, you must use an external battery charger of the correct type to charge the batteries. Follow the charging instructions supplied by the battery manufacturer to charge the batteries.

### USB supply

When you connect the instrument to a PC through a USB cable, the instrument receives power to operate at 5 V DC from the PC. There is no need to use a mains DC power supply to operate the Microdust Pro instrument when you connect it to a PC USB port.

### Battery condition indicator

When the Microdust Pro instrument receives power from a mains DC power supply or from a USB port on a PC, the battery condition symbol on the instrument's screen always shows a fully charged battery condition, even if the batteries are not fully charged.

### 3.2 How to fit the measurement probe

**IMPORTANT:** The instrument might give reading errors when you use it in very bright or changing ambient light conditions. This is because the measurement method depends on the scattering of light.

Take care when you use the instrument in direct sunlight. Shield the probe from direct light sources. You can use a gravimetric or size selective adaptor, or use the instrument within the environmental enclosure to eliminate the effects of high ambient light levels.

The detachable sampling probe houses the measurement chamber together with the associated optics, including the laser diode emitter and detector.

Connect the sampling probe by aligning the red dot on the connector to face forward on the instrument and insert the connector into the socket at the top of the instrument.

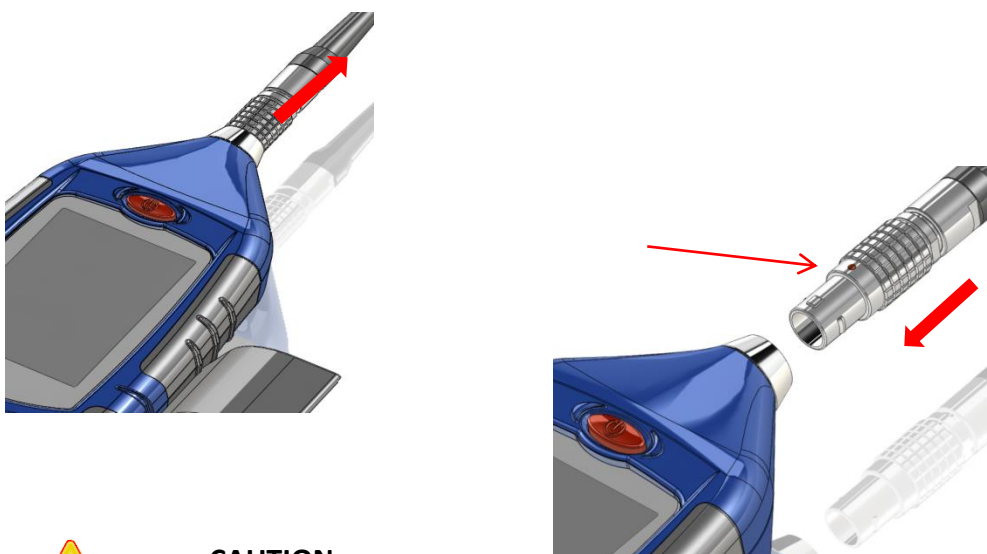

**CAUTION**

DO NOT pull on the cable to disconnect the sampling probe.

To disconnect the sampling probe, pull the connector's knurled outer sleeve directly away from the main body.

The sampling probe may be unclipped from the side of the control unit for hand-held operation.

### 3.3 Using the controls

The Microdust Pro instrument is designed to allow easy operation. The instrument has only seven (7) control keys, shown on the right. These are as follows:

- The Soft keys (A and B).
- The Navigation keys (C) ▶ ◀ ▼ ▲ .
- The Run/Stop key (D) ▶ ■ .

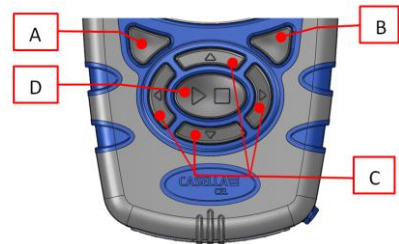

The instrument is small in size, and it is usually possible to hold and operate it using only one hand. For safety, you can attach a wrist strap near the bottom of the instrument.

#### Soft keys

The Soft keys A and B allow you to select between the two options showing at the bottom of the screen. These two options changes, depending on which screen is showing on the instrument's display.

#### Navigation keys

The four navigation keys allow you to select items on the main part of the screen. Press the ▶, ◀, ▲ or ▼ Navigation key to change to the next selection in the direction of the arrow.

#### Run/Stop key

The Run/Stop key ▶ ■ allows you to start and to stop a measurement Run. During a Run, data is saved to internal memory for later download.

Press the ▶ ■ key when the instrument is in the Stop mode (Bars at top and bottom of screen are Red) to start the Run. Refer to section 4.2 Starting a measurement run beginning on page 38 for information about the Run and Stop modes.

Press the ▶ ■ key during a Run to stop the Run.



### 3.4 How to follow the operating instructions

Most of the operating instructions in this User Manual are shown using sequences of screen images. Arrows and numbers explain the sequence of steps that you must perform to complete the operation described by the images.

When an arrow points to indicate a screen icon, use the navigation keys to select that icon. Selected icons are highlighted by a grey border.

This example shows the Settings icon when it is not selected:



And the same icon when it is selected:



The bottom of the screen always shows a wide coloured bar with two instructions. Press the soft key that is below one of the instructions to perform that instruction. The colour of the bar indicates the purpose of the screen. See Colour coding on page 5 for an explanation of the screen colours used.



If the instructions require you to change a value, use the navigation keys to select the character in the value, and to change the selected value.



A full instruction sequence might require you to repeat selections and soft key presses multiple times.

### 3.5 Switch-on

Press the ON/OFF key to switch the Microdust Pro instrument on.

After you switch the instrument on, it shows an introduction screen for a short period. This screen includes the following information about the instrument:

- The instrument’s serial number.
- The firmware version that is operating inside the instrument.
- Two lines of user-defined details, for example the user’s name and telephone number. You must use the Casella Insight Data Management Software to set these details and transfer them to the instrument – you cannot set them by using the instrument’s controls.

Write down these details and save them in a safe location. You must give this information to the service agent if the instrument develops a fault.

#### Status

Following a short delay after switch on, the **Status** screen is displayed. This read-only screen shows the status of some instrument settings. Press the **Exit** soft key to close the **Status** screen and to show the instrument’s measurement screens in **Stop** mode (which means there is no measurement Run in progress). The measurement screens in **Stop** mode have red bars at the top and bottom.

You can also access the instrument's **Status** screen by selecting the **Instrument Status** icon in the **Settings** screen and pressing the **Select** soft key. See the example screens in Figure 5.

Figure 5 Status screen

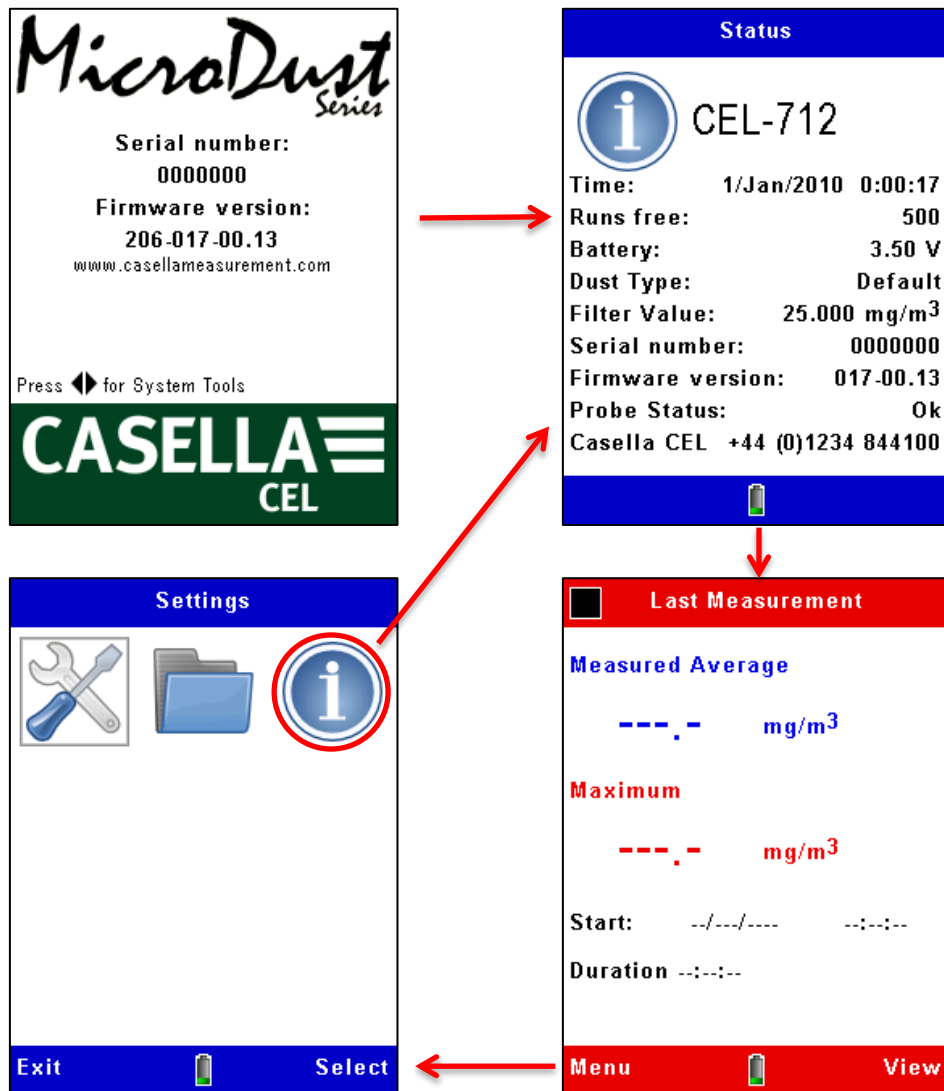

If the instrument has recorded a measurement Run since it was switched on, the measurement screen will show the average and maximum readings from that Run. Otherwise, the data fields will be null: '---.-'.

**IMPORTANT:** Press the Menu soft key from a measurement screen in Stop mode to use the instrument's settings screens as instructed below.

### System tools

If you simultaneously press the left and right navigation keys ◀ ▶ at power up, the instrument displays the **System Tools** screen.

Figure 6 System Tools screen

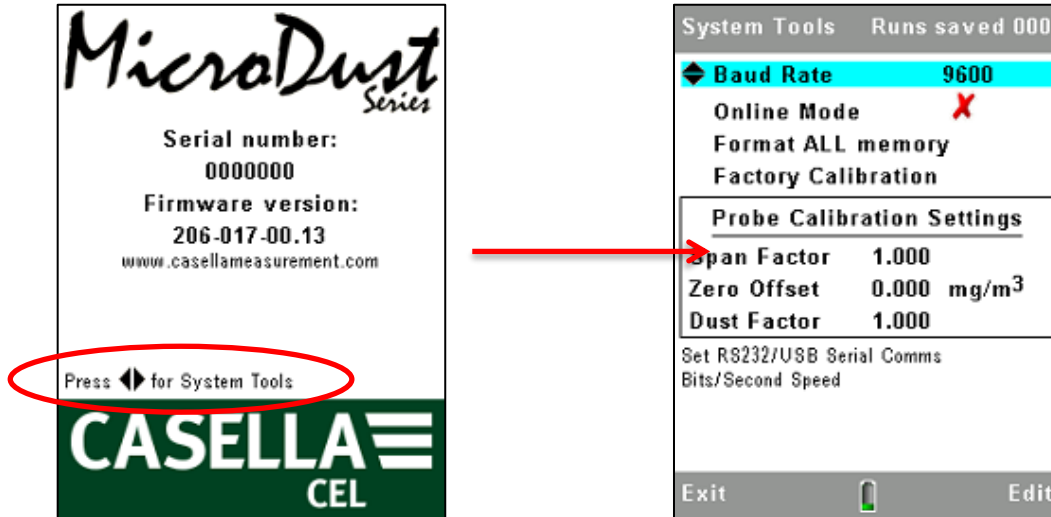

The **System Tools** screen should only be used for diagnostics or to configure the instrument for specialised applications. This screen allows you to do the following:

- Reformat the internal memory. *(This will delete any measurement results or corrupt files saved in memory)*
- Set the serial data communication rate.
- Read the instruments internal Span and Zero calibration settings. These may be used for fault diagnosis purposes
- Reset the calibration values. This sets the internal span factor to 1.0 and Offset value to Zero. It is useful to restore these values during fault diagnosis. After restoring the default values and with the probe in a clean air condition, the displayed concentration should typically be <0.7 mg/m<sup>3</sup>. Higher values may suggest probe contamination.
- Enable 'Online' mode. This is used in telemetry and specialised data logging applications. The instrument automatically starts a data logging Run when powered and provides RS232 serial interfacing of measurements to other products. A cable, part number 206094B provides access to RS232 signals on a 9way female D type connector. Runs will automatically stop at midnight and a new Run will begin.

### 3.6 Set the instrument's display language

**NOTE:** Press the Menu soft key from any of the measurement screens while the instrument is in Stop mode (that is, with red bars at the top and bottom of the screen) to use the settings screens for the following procedures.

The Microdust Pro instrument can display the screens using any of nine languages. When you change this setting, the instrument also changes the format used to display some information, for example the date.

The language options are:

- UK English.
- US English (when using this, only the date format changes).
- Brazilian Portuguese.
- French.
- German.
- Italian.
- Spanish.
- Chinese.

**Figure 7 Setting the display language**

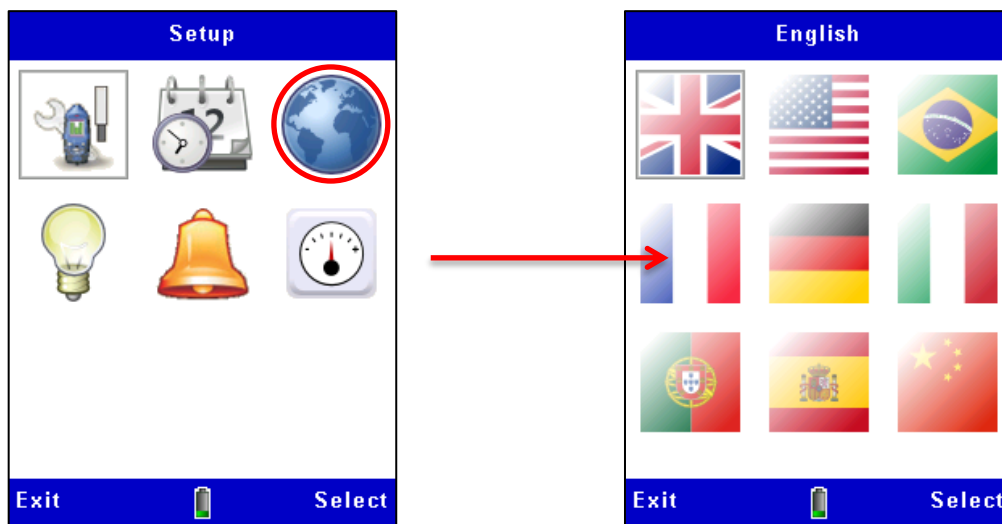

### 3.7 Set the time and date

The Microdust Pro instrument has an internal clock, which allows the instrument to record the date and time of each measurement. The Time Set screen allows you to set the date and the time, and to change the settings when necessary.

1. From the main **Setup** Menu, select the Settings option.
2. Figure 8 shows how to set the time and the date. Press the Save soft key when the second hand of a reference clock reaches the start of a minute to set the exact time for the instrument.

The Time and date may also be set from the PC when using the Casella Insight application.

**Figure 8 Setting the time and date**

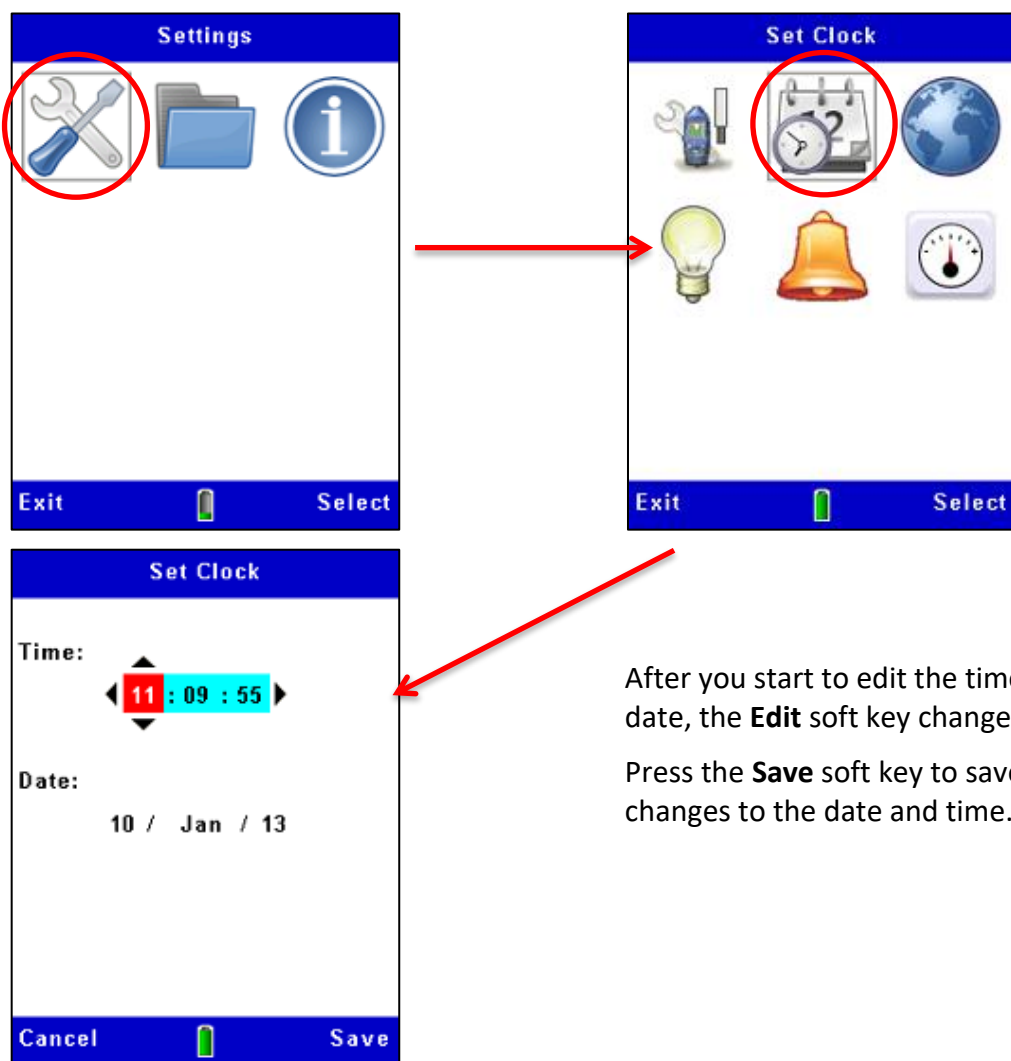

After you start to edit the time and date, the **Edit** soft key changes to **Save**. Press the **Save** soft key to save any changes to the date and time.

### 3.8 Setup

The instrument’s Measurement Settings screen allows you to set up two important features:

1. The particulate type. For a description of this feature and instructions to make these settings, read 3.12 Calibration for specific particulate types beginning on page 33.
2. The logging options described below.

#### Data logging options

The instrument allows you to log data to internal memory so that you can transfer measurements to a computer for analysis and long-term storage. Data is logged during a measurement ‘Run’. The settings required for data storage are:

- Logging interval
- Synchronise log time

Follow the steps in Figure 9 to access the logging setup options. See section 4.2 Starting a measurement run beginning on page 38 for a description of the data logging features.

Figure 9 Data logging setup

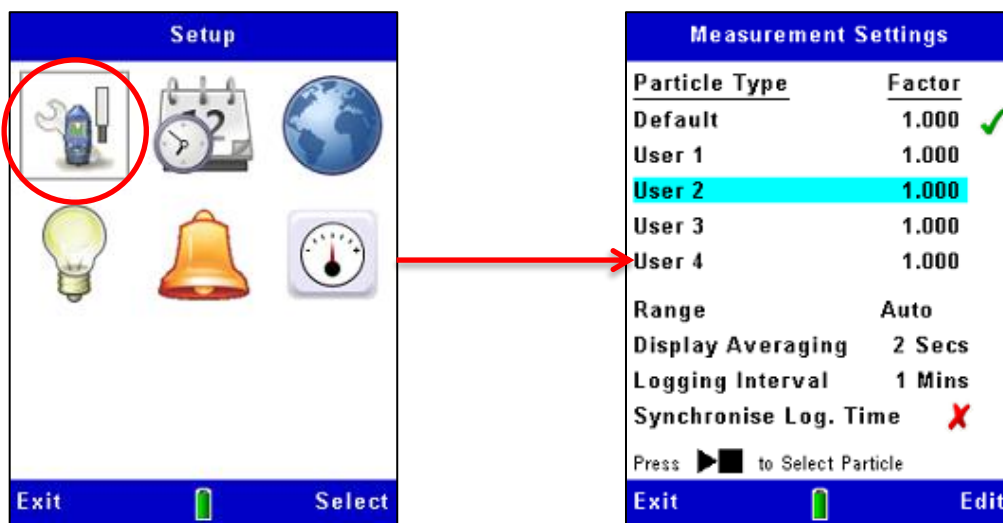

#### Measurement range

All measurement ranges cover zero to the selected maximum. For the majority of applications, the use of ‘Auto’ ranging is recommended. In all cases, measurements resolve to four significant figures with appropriate decimal point position. Select the measurement range which displays the particulate concentration you expect to measure with the greatest accuracy. If you are not sure what the particulate concentration might be, select the Auto range so the instrument can select the most effective range for the measurements it makes.

The standard measurement ranges are 2.5 mg/m<sup>3</sup>, 25 mg/m<sup>3</sup>, 250 mg/m<sup>3</sup>, 2,500 mg/m<sup>3</sup>, 25 g/m<sup>3</sup> and 250 g/m<sup>3</sup>

**Note that operation at high dust concentrations might lead to contamination of probe optics and a failure to operate on the lowest measurement ranges.**

Contaminated ranges will become locked out, however normal operation may be available on other ranges.

### Display averaging period

The displayed particulate concentration is a rolling average of measurements taken over the averaging time that you set. In some applications, where aerosol concentrations change rapidly, you can improve measurement stability by setting a longer averaging time. Averaging periods from 1 to 60 seconds can be selected.

### Logging interval

The logging interval is the time between each recorded data point. Dust values saved at each logging point represent the average dust concentration which has occurred during the logging interval.

Note that data logging stops automatically when the internal memory is full. This means that, for long measurement Runs you should use a long logging interval. Logging intervals from 1 second to 60 minutes can be selected.

See section 8.3 for examples of storage capacity at different logging intervals.

## 3.9 Set the display backlight

The Microdust Pro instrument has a display backlight. The backlight allows you to use the instrument in poor ambient lighting conditions, or in darkness.

The Backlight screen allows you to set the following backlight options:

Set whether the backlight operates automatically, or only after you press a key. You can also set the backlight to remain on permanently.

Set how long the backlight remains on after the last keypress.

Set the brightness level of the backlight.

The operating duration and brightness of the backlight will affect the available battery Run time. Typical battery life is 13.5 hours at medium backlight level.

Figure 10 Backlight setup

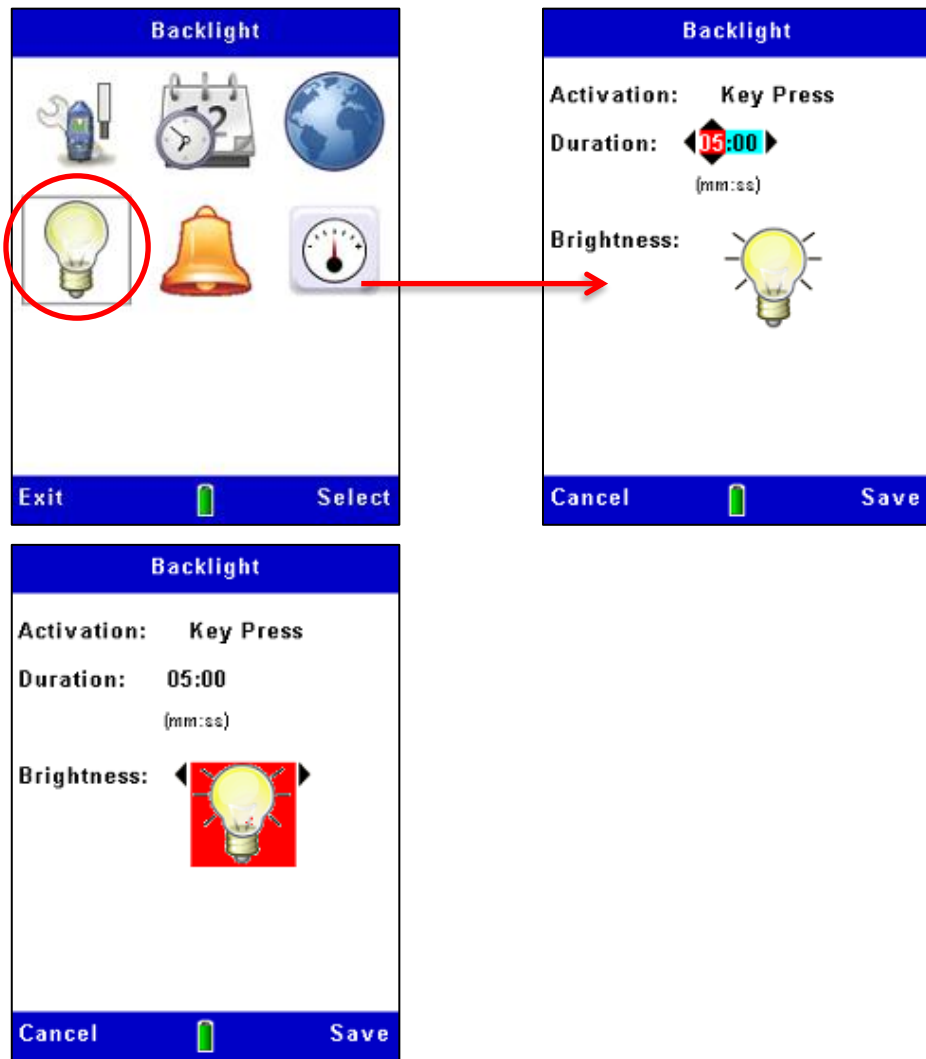



### 3.10 Alarm and analogue output settings

#### Alarm

The instrument’s alarm settings (see Figure 11) allow you to set threshold level for alarm activation and deactivation. To prevent the alarm toggling rapidly between these two states it is also possible to set minimum time periods over which the alarm condition must be satisfied. The alarm’s ‘Off’ threshold level should be set to a suitable value below the activation level.

When the alarm becomes active, the instrument gives the following indications:

- An internal buzzer sounds.
- A visual warning screen is displayed.

The open drain output on the 2.5m output port goes LOW (*Max current 500 mA @ 15 VDC*).

This ‘Open Drain’ output switch may be used to control external devices such as audible audio / visual alarm alarms or a relay for the switching of larger loads.

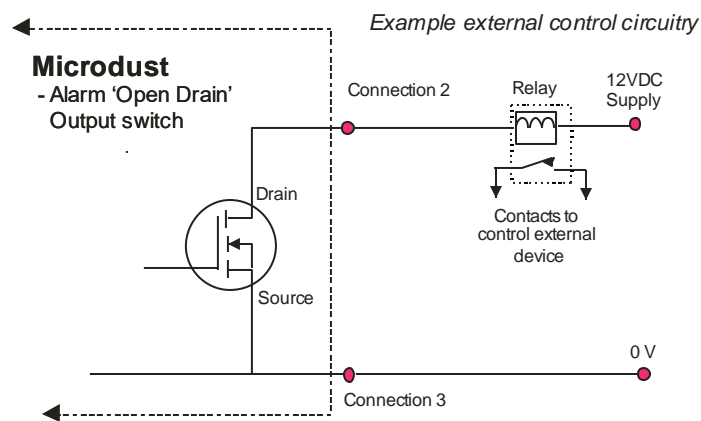

The audible and visual alarm warnings may be cleared by pressing the Accept soft key on the warning screen. The ‘Open Drain’ output will remain active whilst the alarm condition is valid.

Figure 11 Alarm setup

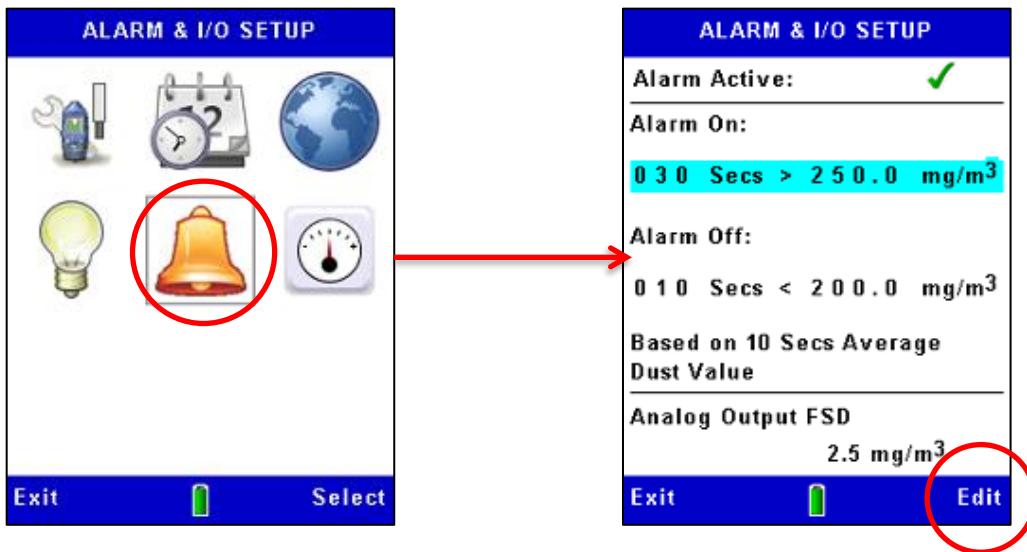

**Analogue output**

The analogue output signal is provided on the 2.5 mm stereo socket located at base of the instrument (See 2.5mm output port). The output voltage varies with the measured and displayed 'Rolling Average' value in the range Zero to +2.5 V DC with a 500 Ω output impedance.

The analogue setup allows you to set the full-scale measurement range for this output. The options are:

- 2.5 mg/m<sup>3</sup>      25 mg/m<sup>3</sup>      250 mg/m<sup>3</sup>
- 2500 mg/m<sup>3</sup>    25 g/m<sup>3</sup>        250 g/m<sup>3</sup>

Unlike the instrument's main measurements, the full-scale analogue output does not auto-range. The appropriate range as shown above must be selected to suit the particulate concentration being measured.

Figure 12 Analog setup

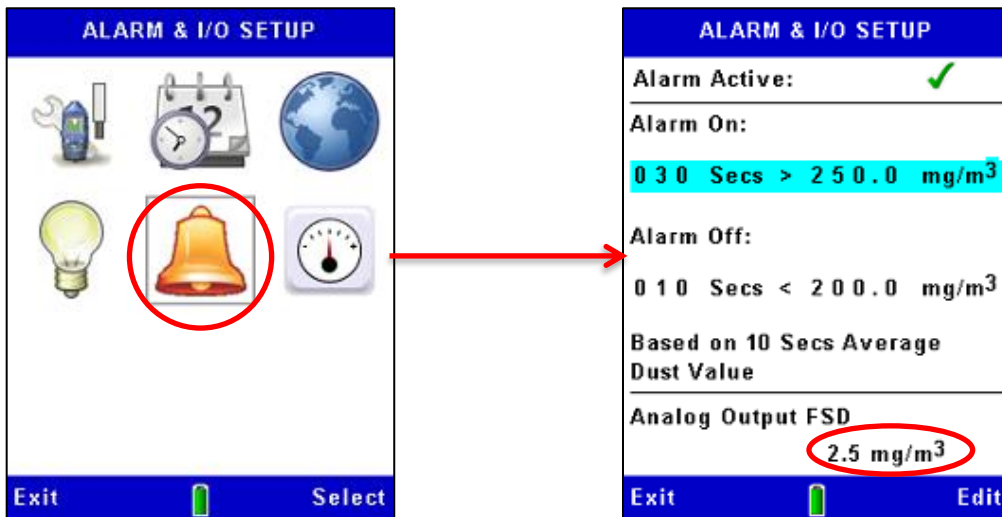

### 3.11 Checking the instruments Zero and Span

The Microdust Pro is a sensitive measuring instrument. Prior to making measurements and to ensure optimum accuracy, it is recommended that the user performs a 'Zero' and 'Span' check.

The Microdust Pro is supplied with an optical 'Calibration Insert' which is used to establish a known instrument sensitivity or 'Span'.

When inserted into the probe, the Calibration Insert creates a stable and fixed scattered effect and signal level. Following the default factory calibration (*using Arizona Road Dust equivalent - ISO 12103 -1 A2 (fine) test dust*) the Calibration Insert will produce a light scattering effect which is equivalent to a factory dust concentration level as shown on the filter label.

Calibration Inserts and probes are supplied as matched pairs, always ensure the correct Insert is used for a given probe.

It should be noted that all optical dust sensing instruments such as the Microdust show a sensitivity to different particulate types due to differences in particle size distribution, material refractive index, particulate shapes and colours. For a given measurement application and dust type, the instrument may show a response different to the factory calibration conditions.

For a given monitoring application (i.e., a specific dust type and conditions) the optimum accuracy of the real time dust measurement is achieved by establishing a calibration factor. A specific 'dust type' calibration factor is derived by the comparison of the Microdusts real time measurement to a co-located gravimetric result (*i.e. using a pump and filter system*). Please refer to the Gravimetric Calibration section 3.12 on page 33.

The instrument's Calibration screens have yellow bars at the top and bottom.

Access these screens by selecting the Calibration icon from the Settings screen.



**Setting for Zero**



Refer to Figure 14 for the steps to set the instrument zero.

Prior to making measurements it is important to purge the probe with clean air and perform a 'Zero' adjustment. Fine dust particles trapped within the probe assembly may take a considerable time to settle, even when the sample chamber entrance holes are covered by the collar.

To purge the probe with clean air, slide the collar over the probe inlet, leaving a small gap (1-3mm) to restrict entry of particulate into sample chamber and from which the purge air can escape. Attach the purge bellows to the probe's purge inlet at the location shown in Figure 13 (*remove the protective rubber cap, ensure you retain it safely and refit once the purging and Zero settings are complete*)

**Figure 13 Probe Purge inlet and Fitting of Purge Bellows**

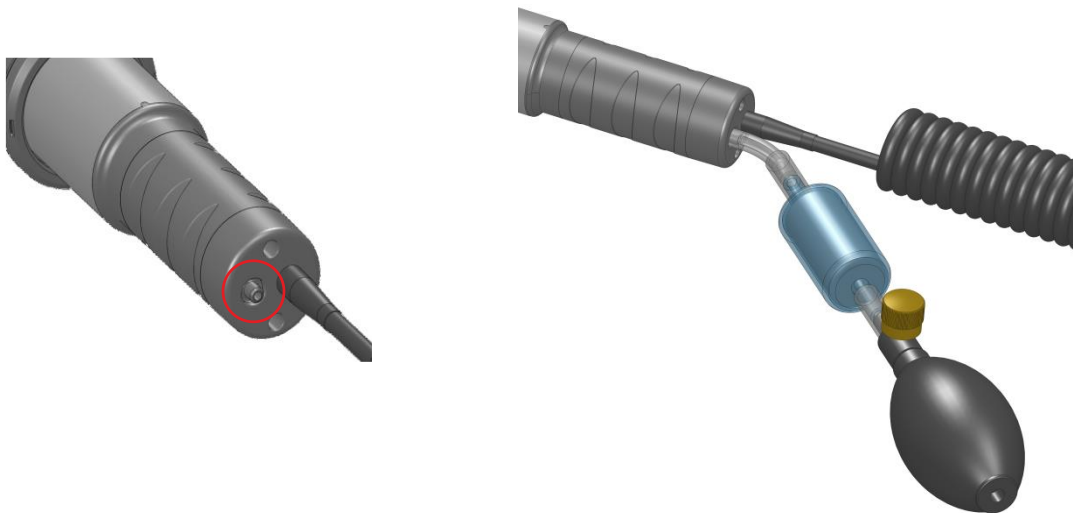

Squeeze and release the purge bellow 5 or 6 times over a 10 second period. This action injects clean air into the chamber and removes possible contamination that might have settled on the optical components inside the probe. When you perform this operation, you might see the indicated concentration increase, and then decrease towards zero.

Allow a few seconds for automatic ranging and for the reading to stabilise. If the reading does not stabilise, squeeze the bulb five or six times and try again.

When the measurements stabilise during the clean-air purge, press the Yes soft key to start the zero adjustment. A progress bar is displayed during the zero adjustment and the screen will indicate whether the calibration is successful. Press the Ok soft key to return to the main Calibration screen.

**IMPORTANT:** If the instrument cannot zero itself in the range 0 to 2.5 mg/m<sup>3</sup>, it displays a 'Contamination Warning' message and selects the 0 to 25 mg/m<sup>3</sup> range. This then becomes the Instruments lowest available range until the probe is cleaned. For accuracy and stability, you should arrange for cleaning to be done by an approved Casella Service centre.

After you have set the zero, make sure you fit the rubber cap on the probe's purge inlet.

Figure 14 Setting the instrument zero

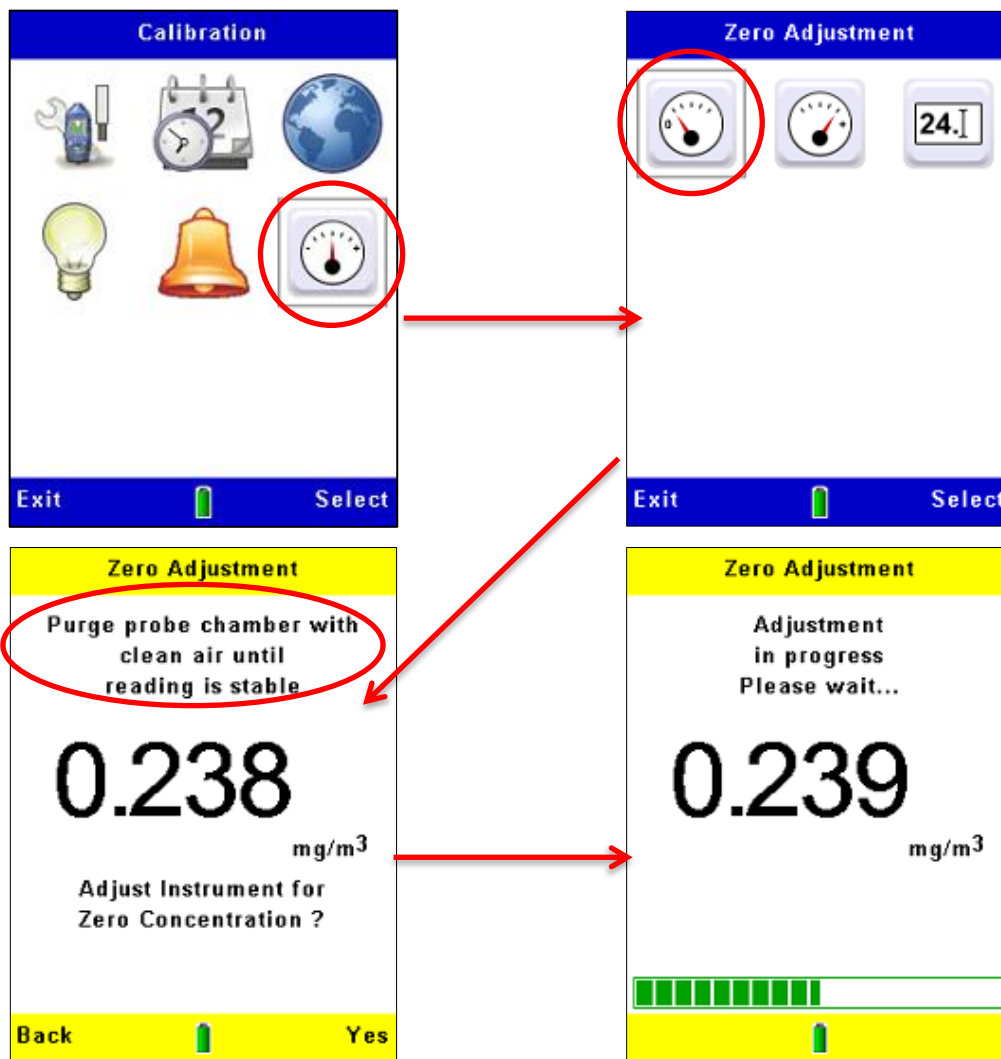

If the calibration fails, purge the probe with clean air for a longer period and then repeat the calibration procedure.

Repeated calibration failures might indicate a possible fault in the probe. Refer to section 9 Maintenance and servicing beginning on page 55.

## Setting the span

The basic settings for span (or sensitivity) for the Microdust Pro instrument are set at the factory using a method traceable back to a wind tunnel isokinetic calibration using ISO12103 -1 A2 (Fine) test dust.

Each probe is supplied with its own Calibration Insert, which creates a fixed optical scattering effect in the sampling space. This fixed reference can be used to confirm the factory calibration point for the instrument and probe.

**Figure 15 Span Calibration Insert**



### IMPORTANT

It is important to use the optical Calibration Insert which matches a specific probe.

The reference value for the Calibration Insert supplied for the probe is shown on the label. This value should be entered within the Microdust using the '**Span Ref.**' icon within the **Calibration** menu.

Fit the Calibration Insert into the probes measurement chamber with the arrow pointing towards the probe's handle as shown in Figure 15. Now perform the Span calibration sequence as shown in Figure 16. There is an automatic delay after you press the Yes soft key to start the calibration, this allows the reading to stabilise.

It should be noted that the dust value displayed during Span calibration uses the Default dust type setting. If a customised Dust type span factor is being used, the factor will be applied to the concentration values shown in the measurement screens.

After successful calibration, the display should show a reading within  $\pm 2$  digits of the value shown on the Calibration Insert. This confirms that the default factory-set sensitivity of the instrument has been achieved.

The span adjustment calibration described here is an absolute calibration of the instrument. It remains valid when a correction factor is applied.

Figure 16 Setting the instrument span

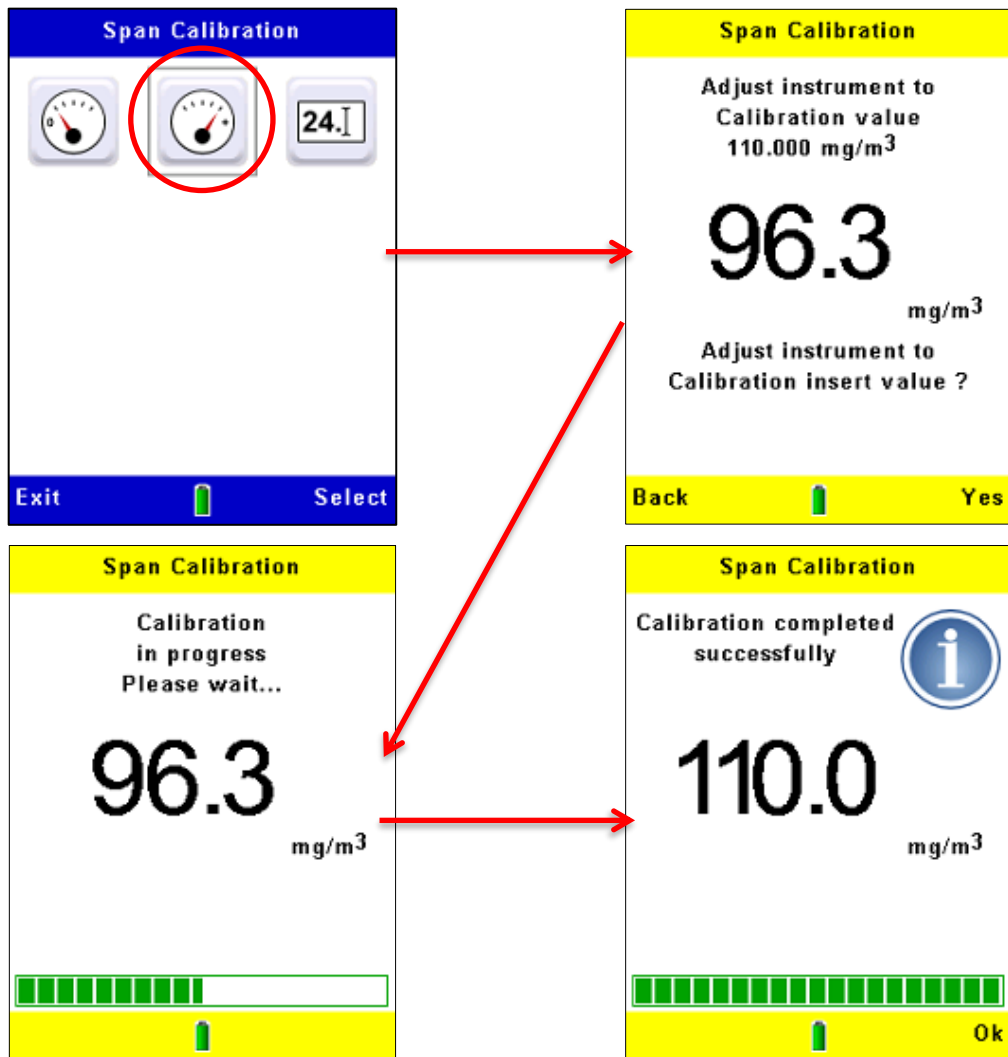

If the correct value is NOT shown (for example because the instrument was last used with a different probe and filter), follow the steps in Figure 17 to set the instrument to use the same reference printed on the Calibration Insert.



Figure 17 Set the Calibration Insert value

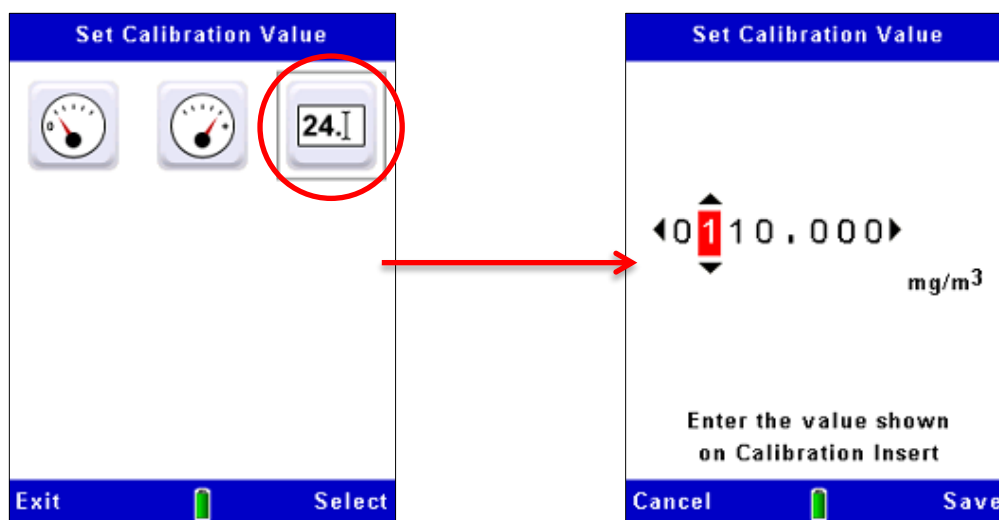

### 3.12 Calibration for specific particulate types - Gravimetric calibration

The measurement sensitivity of the Microdust Pro instrument varies according to properties of the particulate that it is measuring, such as the aerodynamic size, particle shape, material refractive index and colour. This is a common characteristic of all instruments that use light scattering methods for measuring particulate concentration.

The Microdust Pro instrument's use of a narrow forward scattering angle minimises these effects, but for optimal accuracy when measuring a specific particulate type, you should perform gravimetric calibration.

Optional gravimetric and respirable adapters incorporate 37 mm filter cassettes and provide a convenient method of gravimetrically calibrating the instrument. Refer to section 7.1 Sampling Adaptors beginning on page 46 for information about these adapters.

Standard gravimetric techniques can be used to provide a cross-check between the instrument's real-time readings and a weighed example. This is achieved by collecting two average measurements over the exposure period – one from the filter (the gravimetric value) and the other from the instrument's averaging function. If there are differences between the gravimetric value and the instrument's reading, a user-defined correction factor can be entered for the relevant particulate type. This correction factor can then be applied automatically to any measured values to provide optimal measurement accuracy.

#### Gravimetric calibration procedure

During the calibration, you must use the instrument's logging feature to record the particulate concentration measured by the instrument.

1. Follow the instructions on pages 28 to 48 to set the instrument's zero and span.

During the 'Span' setting procedure the instrument is set to the factory default dust type. All user-defined 'dust type' calibrations are relative to this setting. Following Span adjustment, the instrument will revert back to the selected dust type.

2. Fit the gravimetric or respirable adapter onto the instrument’s probe and load a pre-weighted filter into the cassette holder.

See section 7.1 Sampling adaptors beginning on page 46 for a description of the optional gravimetric adapters.

3. Adjust the sampling pump to provide the appropriate flow rate.
  - For isokinetic sampling, the flow rate is calculated from the sample velocity and cross-sectional area of the gravimetric inlet tube (= 200 mm<sup>2</sup>).

$$Flow\ L/min = \frac{60 \times (sample\ velocity(m/s) \times Sampling\ Cross\ Sectional\ Area\ (200mm^2))}{1000}$$

It may be necessary to use a smaller isokinetic inlet diameter to avoid large flow rates.

- For general Total Suspended Particulate (TSP) measurement, the actual flow rate is not critical, but will affect the mass of the collected sample. Typically flow rates of 1 to 2 L/min may be used.
4. Start the gravimetric sampling (*noting the start time or clear the pump Run counter*) and start the instrument’s internal data logger (refer to section 4.2 Starting a measurement run for instructions to use the instrument’s data logging feature).

The instrument calculates and records the average dust concentration for the sampling period.

5. Continue sampling for a period that is long enough to collect sufficient sample mass for accurate measurement on laboratory scales. At low concentrations this may be several hours.
6. At the end of the sampling period, stop the measurement Run and the sampling pump. Note the sampling Run end time and calculate the volume sampled.

The average real-time measurement is available on the display and is stored in an internal data file.

7. Write down the Microdust’s Measured Average value.
8. Condition and weigh the filter to measure the collected mass.
9. Calculate the gravimetric concentration during the sampling period as follows:

$$Gravimetric\ concentration = \frac{Mass\ increase\ (mg)}{Total\ sampled\ volume\ (m^3)}$$

10. Calculate the calibration correction factor as follows:

$$Correction\ factor = \frac{Gravimetric\ concentration\ (mg/m^3)}{Instrument's\ Measured\ Average\ value\ reading\ (mg/m^3)}$$

Example:

Filter mass increase = 3.21 mg

Volume sampled = 0.75 m<sup>3</sup> (calculated from the flow rate and sample time)

Gravimetric concentration =  $\frac{3.21}{0.75} = 4.28\ mg/m^3$

Measured Average value = 3.45 mg/m<sup>3</sup> (meaning the instrument in this example gives readings that are low)

$$\text{Correction factor} = \frac{4.28}{3.45} = 1.24$$

### Applying the correction factor

Correction factors for specific dust types may be set within the instrument's setup menu, accessible via the **Setup icon** in the **Settings** screen.



The setup options include the default particulate type with a correction factor of 1.000 (which you cannot edit), and up to four user-defined particulate types. For each user-defined particulate type you can enter a name and the associated correction factor that you have measured and calculated for it by following the instructions in Gravimetric calibration procedure beginning on page 34.

Refer to Figure 18 for the steps to use the setup mode to enter the name and calibration factor for a user-defined particulate type.

When you use the instrument to measure this type of particulate again, select the appropriate type from the list so the stored correction factor is applied automatically to the measured values.

It should be noted that the use of large correction factor values (i.e., >x2 ) may degrade the instruments noise performance and lead to a reduction in measurement resolution such that the smallest displayed value change exceeds one significant digit on the display.

Figure 18 Applying the correction factor

**Setup**

**Measurement Settings**

Particle Type	Factor
Default	1.000 ✓
User 1	1.000
User 2	1.000
User 3	1.000
User 4	1.000

Range: Auto  
Display Averaging: 2 Secs  
Logging Interval: 1 Mins  
Synchronise Log. Time: ✗

Press ▶ to Select Particle

**SPECIFY A DUST TYPE**

Name: ARD F  
Calibration Factor: x 1.000

q w e r t y u i o p  
a s d f g h j k l Aa  
z x c v b n m ← →

ARD Fine

Press ▶ to Enter Key

**SPECIFY A DUST TYPE**

Name: ARD Fine  
Calibration Factor: x 1.000

◀ 0 2 . 000 ▶

Use the navigation keys to select a letter, then press the Run/Stop key to accept the selected letter

## 4 Making a measurement run

Before you make a measurement, perform the following tasks:

- Adjust the instrument's zero and span settings (see Checking the instruments Zero and Span beginning on page 27)
- Apply the appropriate correction factor (see 3.12 Calibration for specific particulate types beginning on page 33).
- Set an appropriate averaging time for the application (see Display averaging period on page 23).

Start the measurement Run:

1. Open the probe collar fully to expose the measuring chamber.
2. Move the probe through the aerosol by swinging the probe from left to right as shown below. The natural movement of air is used to draw the aerosol into the probes measuring chamber which should be aligned in a horizontal plane.



If sampling via a gravimetric adapter, especially at high concentrations, it is recommended to orientate the probe in a horizontal axis as shown. This enables dust to fall through the sampling chamber thus reducing the risk of optical contamination. If the probe is aligned vertically, there is an increased risk of particulate material 'settling out' due to gravity and subsequently dropping down inside the probe.

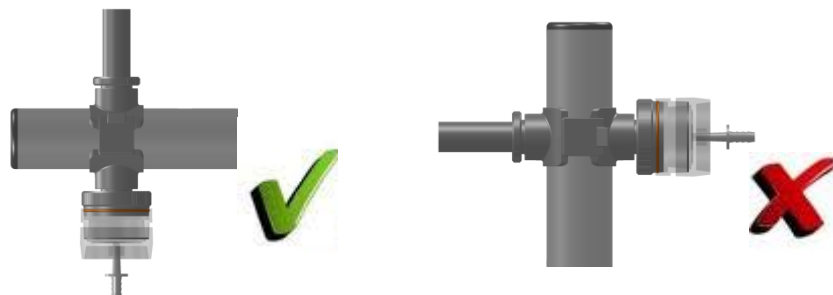

You can make measurements with the probe clipped to the instrument, or you can unclip the probe to allow easy access to confined spaces.

3. Make the required measurements for the application (refer to 4.1 Measurement types below).

## 4.1 Measurement types

In addition to the basic real-time measurements of particulate concentration, the instrument can also calculate and display other useful data.

### Maximum value (Max)

This represents the maximum particulate concentration that occurred in any 1 second period since the measurement Run was started.

You cannot reset the maximum value whilst a Run is in progress.

### Average (Avg)

The average value represents the average particulate concentration since the measurement Run was started.

You cannot reset the Average whilst a Run is in progress.

## 4.2 Starting a measurement Run

The data logging configuration is set using the Measurement Settings screen. See Data logging options on page 22 for an explanation and for instructions to use this screen and the available options.

### Starting a Run

If necessary, follow the instructions in section 4.4 Deleting storage runs on page 42 to clear space in the instrument's internal memory before you start logging measurements. This is important because data logging stops automatically when the memory becomes full.

Press the Run/Stop key  from a measurement screen with the instrument in Stop mode to begin logging data. See the example in Figure 19.

The instrument displays a measurement screen that has green bars at the top and bottom when a Run is in progress.

Press the View soft key to cycle through the sequence of available screens, some of which show measurements as digital readings and some show measurements as graphs.

All the screens in Run mode show basic information such as the elapsed time in the current measurement Run, and the current Run number.

Whilst in the real-time Graph screen, pressing the left and right keys adjusts the graph's X-axis time period.

Data logging continues for a maximum duration of 999 Hrs, 59 mins, 59 secs, after this time the current Run will be saved, and a new Run will start.

An active measurement Run will also be terminated once the internal storage memory becomes full.

Figure 19 Start logging

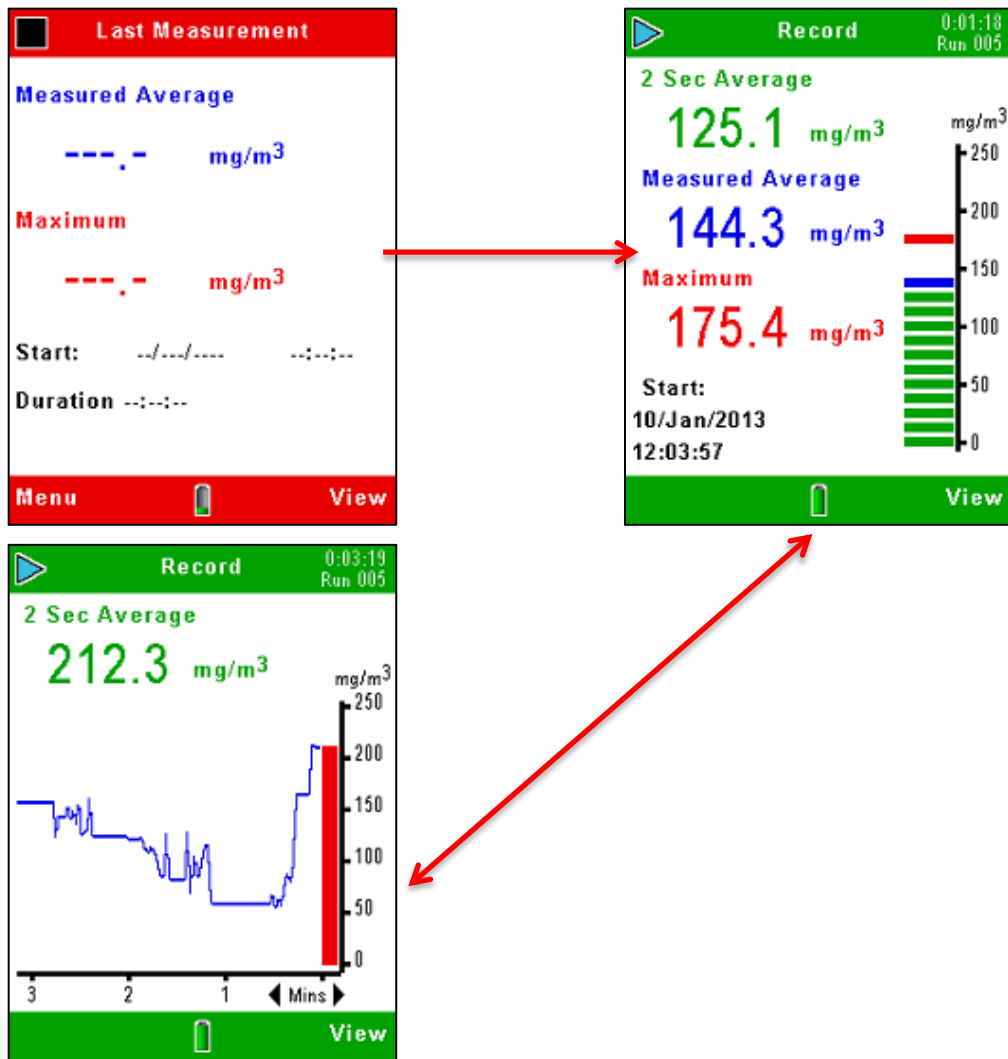

### Stop logging

Press the Run/Stop key ▶ ■ from any of the measurement screens in Run mode to stop the logging and return the instrument to the Stop mode. The instrument stops at the next second after you press the Stop key.

The logged information is stored internally under a file name that shows the relevant Run number. The file includes information about the average and maximum particulate concentration during the Run, and the date and time when the measurement was started.

Figure 20 Stop logging

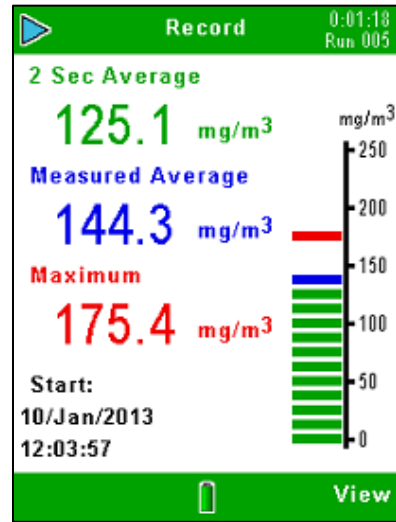
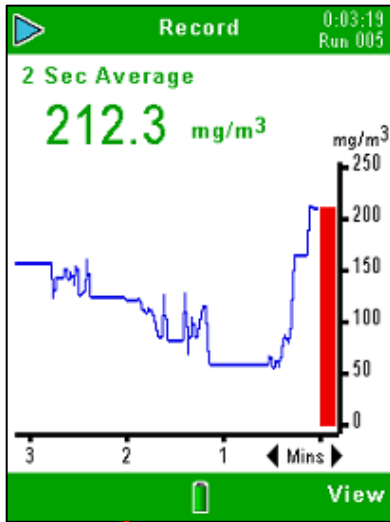

▶ ■ (Press Run/Stop Key)



▶ ■ (Press Run/Stop Key)



### 4.3 Viewing stored Runs

The Microdust Pro stores measurement Runs in internal memory and identifies them by the date and time when they were started. The first **Memory Results** screen shows a sequence of dates and lists the number of Runs recorded on that date, with the most recent date at the top of the list. Figure 21 shows the steps to follow to view the list of stored measurement Runs.

**Figure 21 Viewing a list of stored Runs**

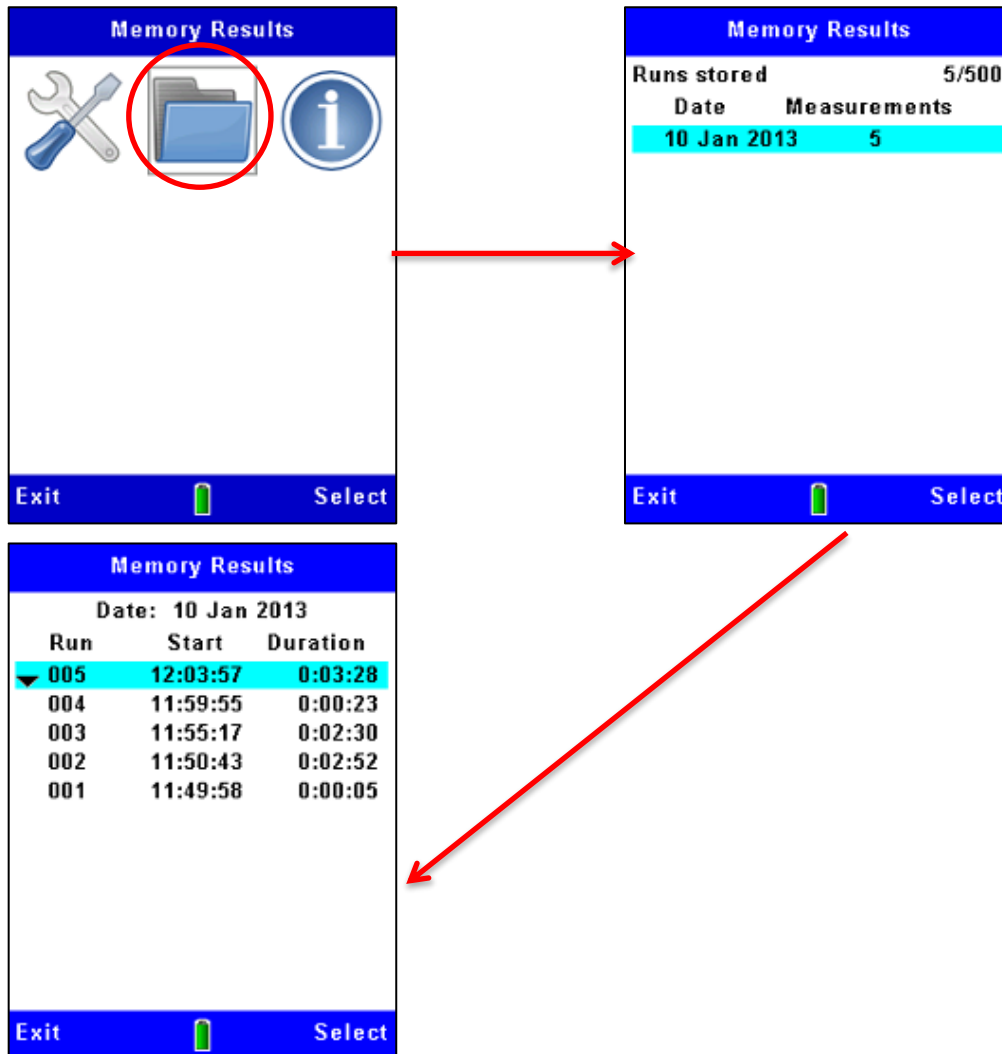

Use the up and down navigation keys ▲ ▼ to select one of the dates in the list and press the Select soft key to show all the Runs recorded on that date. The Runs on each date are numbered sequentially beginning at Run 01. The earliest Run on a date is at the top of the list.

After you have selected a Run in the Memory Results screen, you can follow the steps shown in Figure 22 to view a summary of that Run. To view a more detailed analysis of any Run, you must connect the instrument to a PC Running the Casella Insight Data Management Software and use the facilities made available in that application.

Figure 22 Viewing details of a stored Run

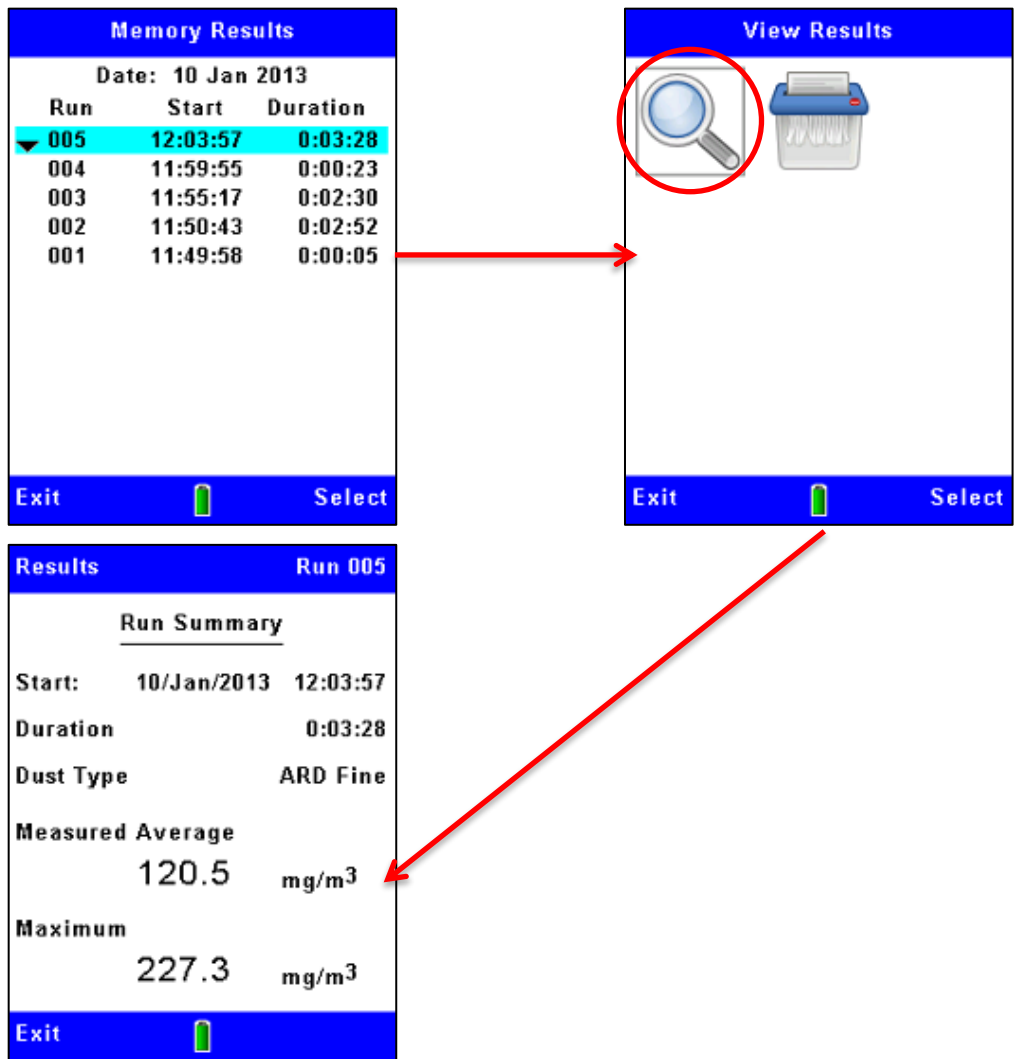

## 4.4 Deleting stored Runs

Data logging stops automatically when the internal memory becomes full. For this reason, it is good practice to delete Runs in the memory to clear space for new Runs. The steps in Figure 23 explain how to do this.

Figure 23 Deleting stored Runs

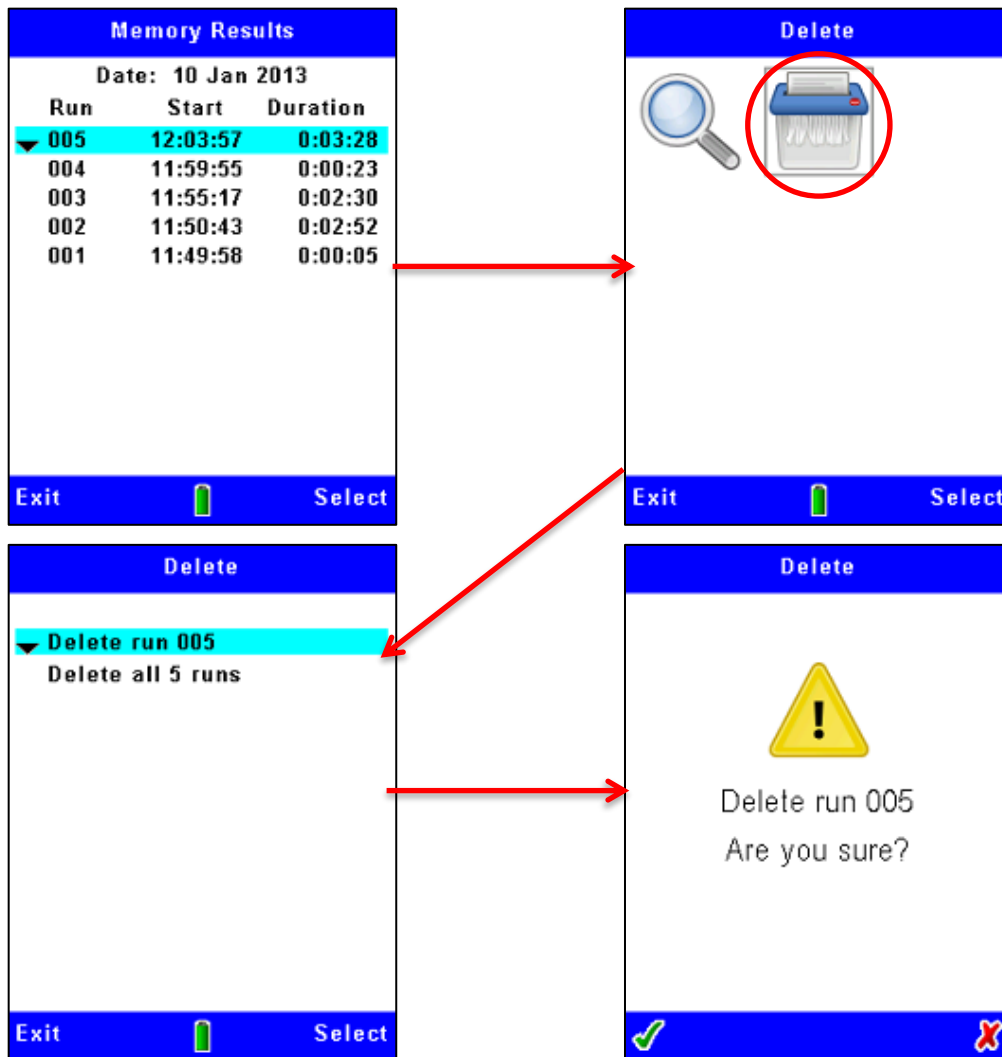

**Note:** when you delete Runs from the instrument’s internal memory you cannot restore them again! Before deleting data files within the instrument, always use the Casella Insight Data Management Software application to safely transfer and save results to the PC. The Microdust Pro will always seek confirmation to proceed with Run deletion.

## 5 USB connection

The Microdust Pro instrument has a ‘Mini B’ USB port that allows you to connect the instrument to a PC Running Windows® XP or later.

The PC will show a connected Microdust instrument as a removable drive, and identifies it by an available drive letter, for example E:

The Microdust mass storage drive is read only and will contain data files in ASCII CSV format (if any measurement files have been saved!) plus an ID file which contains details of the Instrument setup. These files may be opened directly using a Spreadsheet or text editing application.

The Casella Insight application should be used to download recorded results to the PC.  
See Mini B USB port on page 11 for information about the connection.

## 6 Insight data management software

The Casella Insight Data Management Software includes a plugin for the Microdust Pro instrument family. The software supports the following:

- Instrument configuration
- Data downloading
- Data management and analysis
- Reporting functions

The Insight application Runs on a PC that meets the following minimum specifications:

Operating System: -

- Windows XP (Service Pack 2, and >1.3GHz processor and ≥1GB RAM)
- Windows Vista (Service Pack 2)
- Windows 7 (Service Pack 1)
- Windows 8
- Windows 10

Refer to the software's on-line help for a complete description of its features, and for instructions to use the software with the Microdust Pro instrument.

This section of the manual explains how to do the following tasks:

- Install the Casella Insight Data Management Software on a PC
- Start the Insight Data Management Software
- Access the on-line help system

## 6.1 Installing and starting the Insight Data Management Software

**Note:** You should perform the installation procedure while operating the PC under administrator privileges.

1. Insert the CD that holds the software into the PC's CD-ROM drive.
2. If the software does not start to install automatically, use Windows Explorer to display the contents of the CD, double-click the Insight folder then double-click the **setup.exe** file on the CD.
3. Wait until the Casella Insight Welcome screen is displayed, and then follow the on-screen instructions.

When the installation process gives you an option, choose the default settings.

When the installation finishes, a new 'Insight' icon is displayed on your PC's desktop.

Following installation, it is recommended to re-boot the PC to ensure Insight's SQL framework is fully operational.

Double-click the Insight icon to start the software.

When the software is running, press the PC's **F1** function key to display the on-line help system, which tells you how to use the software with the Microdust Pro instrument. Refer to the on-line help for all instructions to use the software.

## 7 Sampling accessories

When you use the Microdust Pro instrument in static monitoring applications, you should use some form of aspiration with the sampling probe. This can be a TUFF Air Sampling Pump.

By maintaining an air flow through the sampling probe, you can eliminate possible errors caused by the orientation of the probe's inlet and size selectivity.

The gravimetric and respirable adapters include 37 mm filter cassettes and provide a convenient method of calibrating the instrument.

### 7.1 Sampling Adapters (PUF Size Selective and Gravimetric TSP)

The gravimetric adapter units draw particulate matter through the sampling probe's measuring chamber and deposit it on a 37 mm filter. There are two gravimetric adapter options available:

- **Total Suspended Particulate (TSP)**  
When no size-selective sampling inlet is used, the instrument measures all particulate that can be 'seen' by the optical detection system. This might not represent all airborne material because very large and very small particles cannot be seen.
- **Polyurethane Foam Filter (PUF)**  
Respirable, PM10 and PM2.5 measurements can be made using a PUF size-selective inlet system.

These adapters allow you to use standard gravimetric methods to cross-check readings from the instrument against a weighed sample.

All components of these adapters fit together using O-ring seals. You should check the O-rings regularly and fit new O-rings if there are any signs of damage. Damaged O-rings can cause measurement errors due to air leakage.

If errors exist between the instrument's measurements and the true gravimetric value, you can determine and apply a correction factor to the instrument's measurements. See 3.12 Calibration for specific particulate types beginning on page 33 for instructions to do this.

Align and insert the sampling probe into the adapter block. Insert the adapter's locating spigot into the probe's inlet so that the adapter cannot rotate or move on the probe.

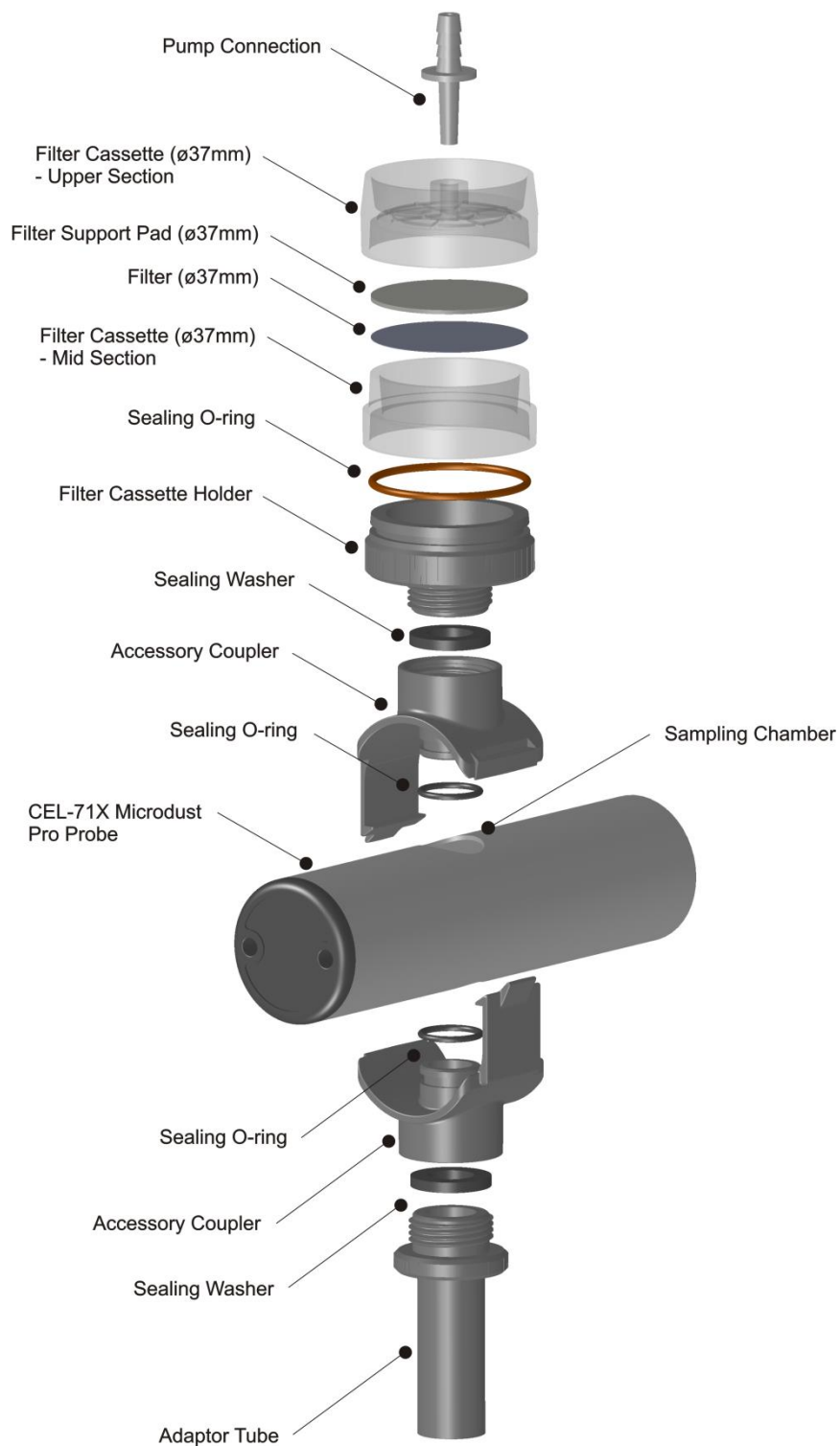

Figure 24 Microdust Pro Gravimetric Adaptor (Ø37mm Filter)

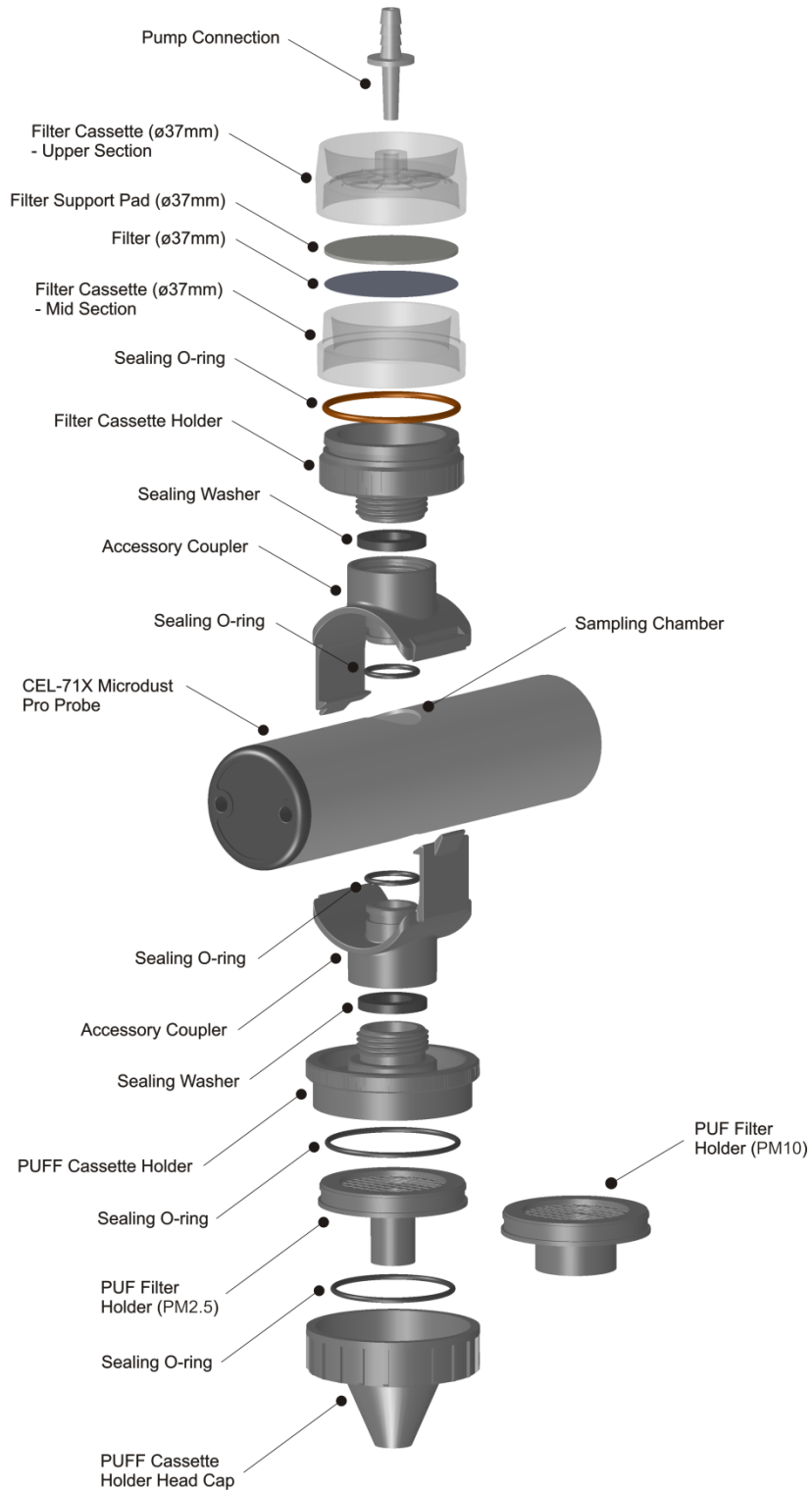

Figure 25 Microdust Pro PUF Size Selective Adaptor (Ø37mm Filter)



The basic design of the Gravimetric (TSP) and Size Selective Adapters (PUF) are the same, but with different inlet fittings.

### PUF Size Selective Adapter

The polyurethane foam filter (PUF filter) adapter is for use in PM<sub>10</sub>, respirable and PM<sub>2.5</sub> sampling applications that have a flow rate of 3.5 litres/minute. The design is based on the Conical Inhalable Sampler (CIS), which is identified in the Health and Safety Executive's publication MDHS14.

For monitoring applications, the adapter is fitted to the sampling probe as shown in Figure 25.

The air sample is drawn through the PUF filter and then into the instrument probe's measuring chamber before being deposited onto the filter (37 mm).

The type of foam filter loaded into the adapter determines the size of particulate matter being monitored by the instrument and being collected on the filter.

The PUF filter inserts have been designed as size-selective filters to capture particles that are larger than a specified mean aerodynamic size. However, it is also possible to pre-weigh and post-weigh the PUF inserts to determine the total inhalable size dust fraction value and the desired size fraction.

PUF filters should be stored in a clean and, preferably, air-conditioned environment.

If used without PUF filters, the adaptor will provide the total inhalable size dust fraction if the pump is run at 3.5L/min.

To insert or remove PUF filters from their filter cassettes, use clean tweezers and vinyl gloves. Do not allow the filters to become damaged, creased or folded in any way.

Spare PUF filters are available from Casella:

- PM<sub>2.5</sub> foams (packs of 10)                      Part Number P118204
- PM<sub>10</sub> foams (packs of 10)                      Part Number P118206
- Respirable 2 foams (packs of 10)              Part Number P118208

### Probe contamination

When using any of the Gravimetric adapters we recommend that sampling is performed with the probe orientated horizontally (*This reduces the risk particulate material falling onto the optical lens elements located at each end of the probe*). Excessive build-up of dust on lens components may result in a large 'Zero signal' level and the disabling of lower 'contaminated' measurement ranges.

## 8 Specifications

### 8.1 Instrument specification

Instrument Specification	
Sensing technique	Forward light scattering using visible red semiconductor laser light (wavelength 635 nm <5 mW).
Laser classification	The Microdust Pro is a Class 1 Laser Product complying with 21CFR1040 with deviations pursuant to Laser Notice 50 and with IEC/EN60825-1:2007.
Measuring ranges	0.001mg/ m <sup>3</sup> to 250 g/m <sup>3</sup> over six ranges: <ul style="list-style-type: none"> <li>• 0 to 2.5 mg/m<sup>3</sup></li> <li>• 0 to 25 mg/m<sup>3</sup></li> <li>• 0 to 250 mg/m<sup>3</sup></li> <li>• 0 to 2500 mg/m<sup>3</sup></li> <li>• 0 to 25 g/m<sup>3</sup></li> <li>• 0 to 250 g/m<sup>3</sup></li> </ul> The active range can be fixed or auto ranging.
Measurement resolution	0.001 mg/m <sup>3</sup> on 2.5 mg/m <sup>3</sup>
Zero stability	Typically <2 µg/m <sup>3</sup> /°C
Span stability	Typically <±0.2 % of reading/°C
Temperature	Operating 0 °C to 55 °C (non-condensing) Storage -20 °C to +55 °C (non-condensing)
Power consumption (at mid LCD brightness)	<ul style="list-style-type: none"> <li>• From external 12 V DC supply = 110 mA</li> <li>• From 3.6 V battery supply = 210 mA</li> <li>• From 4.5 V battery supply = 175mA</li> </ul>
Battery	Three AA / MN1500 cells Alkaline or rechargeable NiMH
Battery run time	Alkaline / NiMH (2700 mAh) Typically, 13.5 hours at medium backlight level 9 hours at maximum backlight level
Universal power adapter (-PC18)	Input voltage range: 100 V to 240 V AC 47 Hz to 63 Hz Output: 12 V DC at 0.8 A Supplied with connectors suitable for USA, UK, European, and Australian mains outlet sockets.

DC power operation	The instrument can be operated continuously from the - PC18 power adapter. The instrument will switch on automatically after application of an external 12 V DC supply.
Display	320 × 240 pixel TFT Colour LCD graphics
Keypad	Seven-key tactile keypad
Weights	Instrument Body: 320 g ( <i>including batteries</i> ) Probe: 250 g Complete kit in case: 4.0 kg approximately
Dimensions	Instrument Body: 72 mm wide x 172.0 mm high x 33.0 mm deep Probe: 35 mm diameter x 205 mm total length Carry case: 427 mm wide x 110 mm high x 325 mm deep

## 8.2 Displayed values

Displayed Values	
Rolling average	Represents the rolling average of instantaneous particulate concentration over a user-selectable time period from 1, 2, 3, 4, 5, 10, 15, 20, 30, 60 seconds.
Measurement average	Represents the accumulated average dust concentration since a logging Run was started.
Max value	Represents the maximum rolling average value (updated every second) since a data logging Run was started.
Scrolling graph	<p>The graph view provides a real-time trend indication of the particulate concentration over time.</p> <p>Use the left / right keys select graph time base periods of 1, 2, 5 and 15 min.</p> <p>The Y-axis can be set to a fixed range or can be auto-ranging.</p>
Factory calibration	<p>The instrument is factory calibrated using a method traceable back to isokinetic techniques using ISO 12103-1 A2 Fine test dust (<i>Arizona road dust equivalent</i>).</p> <p>Four user-defined dust type settings are available to suit specific types of particulate or particular monitoring applications.</p>
Routine calibration	<p>The instrument's software provides a simple calibration routine for zero and span settings.</p> <p>The instrument allows confirmation of the factory calibration point by using an optical Calibration Insert.</p>

## 8.3 Data logging

Data Logging	
Internal memory	3 MB Non-Volatile FLASH memory providing capacity to store > 86000 data points.
Example capacities	<p>Logging every 1 s = 24 hours</p> <p>Logging every 5 minutes = 301 days</p> <p>Logging every 15 minutes = 2.4 Years</p>
Logging interval	Adjustable from 1, 2, 5, 10, 15, 20, 30 seconds, 1, 2, 5, 10, 15, 20, 30 to 60 minutes. Data logging stops after memory is full.
Recorded values	Average concentration over the logging interval.

	Maximum and average values for the entire logging period are saved at the end of each logging Run.
Data files	Data may be extracted using the Casella Insight Data Management Software. Files use Comma separated ASCII format and may be imported into many other text-based applications.
Maximum run duration	Longest individual Run duration is 999 hours, 59 mins, 59 secs after which the active Run is closed, and a new Run is automatically started.
Real-time clock	Internal clock accuracy <1 minute / Month.
Communication interface	'Mini B' USB 1.1 ( <i>Supporting CDC Composite Serial and Mass Storage Classes</i> ). RS232 from 1200 to 115k baud.
Analogue output	0 V to 2.5 V DC FSD, 500 Ω output impedance. The Analog full scale signal may be configured to represent any dust concentration range, ( <i>for example, 2.5 V FSD = 25.00mg/m<sup>3</sup></i> ).
Alarm output	Alarm status may be triggered and reset based upon user defined trigger levels and exceed times. Alarm warning is by audio buzzer and Open Drain switch output (15 V DC and 500 mA) maximum load).
Maintenance	Depending on the instrument's dust exposure, cleaning may be required annually or more frequently under severe measuring conditions.

## 8.4 Optional accessories

Accessories	
180043B	Extension cable for sampling probe (10 metres).
206105D	Dust Detective Kit (Less Tuff Sampler).
206101B	Gravimetric Sampling Adapter.
206102B	Size Selective Sampling adapter (PUF).
206094B	'Mini B' USB to 9-way Female D Type RS232 connector. adapter cable – for real time RS232 output streaming to a PC or for connection to other equipment.

## 8.5 Standards compliance

The Microdust Pro instrument complies with EMC Directive 2014/30/EU of the European Union. It has been tested according to the standard delivery schedule and complies with the following standards:

Standards	
<b>EN 61000-6-1:2019</b>	Electromagnetic compatibility (EMC) Part 6-1: Generic standards – Immunity for residential, commercial and light-industrial environments.
<b>EN 61000-6-2:2019</b>	Electromagnetic compatibility (EMC) Part 6-2: Generic standards – Immunity for industrial environments.
<b>IEC 61000-6-3:2017+A1:2011 (E)</b>	Electromagnetic compatibility (EMC) Part 6-3: Generic standards – Emission standard for residential, commercial and light-industrial environments.
<b>IEC 61000-6-4:2007+A1:2011 (E)</b>	Electromagnetic compatibility (EMC) Part 6-4: Generic standards – Emission standard for industrial environments.

## 9 Maintenance and servicing

Casella has an in-house service department that provides a complete range of repair and calibration services for products manufactured by Casella. Please contact the service department at the Bedford Headquarters or your local representative for details of the full range of services available.

To return equipment for repair, pack it properly into the original packing materials or a good equivalent and send it fully insured and pre-paid to the following address:

Casella  
(Service Department)  
Regent House  
Wolseley Road  
Kempston  
Beds MK42 7JY  
United Kingdom

**IMPORTANT:** Any instruments returned for repair should be accompanied with a document identifying:-

A full list of the package contents.

Symptoms of the fault condition or servicing requirements.

Details of any repair or calibration work required.

For servicing outside the United Kingdom, return the instrument to your local Casella Office or representative.

### 9.1 Lens contamination

In common with all items of optical equipment, the Microdust Pro instrument's lenses can become contaminated with particulate matter that settles on exposed surfaces. Over time, this can reduce the instrument's accuracy, or can make it difficult for the instrument to give a stable zero reading.

The optical chamber and lens arrangement on the instrument probe have been designed carefully to reduce the need for cleaning. However, to extend the serviceable life of the instrument you should perform this task after each measurement operation.

Rigorous purging with clean air from the purge bellow might help to clean and dislodge any severe contamination from within the probe.

If the probe becomes heavily contaminated following regular use in high dust concentration conditions (*as identified on the status screen*), lower measurement ranges (*especially 2.5 mg/m<sup>3</sup>*) will become disabled. The instrument will however continue to operate on higher ranges.

#### Cleaning the lens

1. Attach the air purge bellows to the probe's purge inlet.
2. Move the probe collar to open the sampling chamber.

3. Pump vigorously to blow clear any dust or contamination on the lens surface.

### Continuous purge technique

For specialist long-term sampling applications, or where you expect to make high concentration measurements, it is possible to use a continuous source of clean, dry and filtered air to purge and protect optical components within the probe. Maintain a purge flow rate of approximately 5-10 % of the main sample rate.

Whenever continuous purging of probe optics is used, the particulate sample must be drawn into and through the probe's measurement chamber by the use of a larger sampling flow rate. If you do not do this, the clean air used for purging will prevent entry of particulate matter. The purge air flow will have a dilution effect and for this reason it is recommended that the entire sampling system is calibrated against a gravimetric result to achieve optimum accuracy.

If the probe optics become heavily contaminated, it will be necessary to return the instrument to Casella for cleaning and re-calibration. Note that the instrument warranty does NOT cover this operation or general servicing of the instrument.

## 9.2 General maintenance

Use a clean, slightly damp cloth to wipe the outside of the instrument. Do not use abrasive, caustic or solvent materials to clean the instrument.

Check the condition of the battery compartment when you fit batteries to the instrument. Check for signs of corrosion and arrange any repairs necessary.

Remove the batteries from the instrument if it will not be used for a long period of time (more than one month).

Do not allow the instrument to become wet. Avoid sampling high humidity or wet particulate samples. When moving instrument from a cold to warm environment, condensation on optical components may temporarily disturb correct operation.

The Microdust Pro is a sensitive optical instrument. Avoid severe mechanical shocks or dropping.



### 9.3 Servicing hints

There are no user-serviceable parts inside the Microdust Pro instrument or sampling probe. DO NOT open these items.



**WARNING – CLASS 1 LASER PRODUCT**

The Microdust Pro instrument is an enclosed Laser based system.

The internal laser radiation is the equivalent of Class 2 under normal conditions and potentially 3B under fault conditions.

Laser Source <20mW @ 638 nm.

Risk of Visible Laser Radiation when opened. Avoid exposure to beam.

This product shall only be opened by authorised and competent personnel.

**IMPORTANT:** If you suspect the instrument has an electrical fault, or if a fault persists after you perform the servicing hint listed below, return the instrument to Casella for repair.

**Table 1 Servicing hints**

Fault symptom	Possible cause	Service hint
The instrument does not switch ON.	Batteries are discharged.	Replace or Recharge the batteries.  Use an external power supply.
The probe always reads zero.	A fault may exist on the laser transmitter or receiver.	Check the probe connection.
There is a continuous 'over range' indication.	Optical misalignment due to mechanical shock.  Excessive contamination.	If repeated purging of the probe with clean air does not fix the problem then please return the instrument to Casella or your local Casella representative for optical alignment, cleaning and re-calibration.
Zero is unstable or drifts when the probe collar covers the sampling chamber.	Sample chamber contamination by dust.	Follow the technique in section 9.4 Lens contamination on page 55 to clean the sample chamber.  Follow the technique in Setting for Zero on page 28.
A probe contamination message is displayed.	Optical misalignment due to mechanical shock.  Excessive contamination.	Purge the probe with clean air from the bellows pump.

# 10 Servicing and warranty arrangements

For details of warranty terms and conditions, please refer to the Casella web site at [www.casellasolution.com](http://www.casellasolution.com).

## 10.1 Inspection and test

To make certain the instrument conforms to its published specifications, the instrument is tested thoroughly, and its accuracy is verified before shipment from the factory. All technical information about each individual instrument is filed under the instrument's serial number, which you should include in any correspondence concerning this instrument.

## 10.2 User servicing

There are no user-serviceable components inside the Microdust Pro instrument or the sampling probe.



### **WARNING – CLASS 1 LASER PRODUCT**

The Microdust Pro instrument is an enclosed Laser based system.

The internal laser radiation is the equivalent of Class 2 under normal conditions and potentially 3B under fault conditions.

Laser Source <20mW @ 638 nm.

Risk of Visible Laser Radiation when opened. Avoid exposure to beam.

This product shall only be opened by authorised and competent personnel.

DO NOT open the instrument or the probe to attempt repairs. Warranty will be void if you attempt to open the instrument or the probe for any reason.

If you suspect the instrument has developed a fault, contact your local Casella office or representative for service and repair.

# Appendix – serial communication interface

## Command set for remote control

The Microdust Pro instrument may be interrogated and controlled using a simple serial communications protocol. A terminal emulation program, for example Microsoft 'HyperTerminal' may be used to communicate with the instrument.

The mini USB socket located on the base of instrument includes physical connections for both USB connectivity and also RS232 level serial communications. Access to the RS232 signal level connection pins may be achieved using the cable assembly 206094B which provides a standard female 9-way D type RS232 connection.

In USB connected mode to a PC, the instrument supports 'Mass Storage' and 'CDC Serial Communication' device classes.

The RS232 hardware connection method is suited to the connection of non-PC based devices such as data loggers.

The RS232 baud rate may be selected in the 'System tools' menu from 1200 baud to 115k baud. The RS232 serial communication parameters are fixed at using 8 data bits, 1 stop bit and no parity.

RS232 and USB serial communication methods should not be used simultaneously.

The following set of commands may be used to control and interrogate the instrument:

### Command X – Start real-time output

The instrument transmits the average particulate measurement as it is displayed on the screen. The measurement updates at intervals of 1 second.

Each transmission terminates with the carriage-return line-feed characters (ASCII characters 0x0A 0x0D).

Example

```
2.87<CR><LF>  
2.55<CR><LF>  
2.60<CR><LF>
```

### Command Z – Stop real-time output

The instrument stops transmitting the real-time data output.

### Command I – Interrogate target

The instrument transmits a comma-delimited string of characters that contain two ID strings.

- The first ID string is the number of records stored in the logger.
- The second ID string is the firmware version of the instrument.

Example

```
CasellaCEL, (01234) 844100,K, 11,80-176087AXX<CR><LF>
```

## Command T – Download records stored

The instrument downloads all records stored in its internal memory to the PC.

### Example

```
Log close, 28/07/03,12:13:48, 129.396, 129.445,28/07/03,12:13:42,0 [CR] [LF]
28/07/03,12:13:48, 129.361, 1 [CR] [LF]
28/07/03,12:13:46, 129.387, 2 [CR] [LF]
28/07/03,12:13:44, 129.439, 3 [CR] [LF]
Log close, 28/07/03,12:11:30, 240.920, 240.947,28/07/03,12:11:22,4 [CR] [LF]
28/07/03,12:11:30, 240.882, 5 [CR] [LF]
28/07/03,12:11:28, 240.909, 6 [CR] [LF]
28/07/03,12:11:26, 240.897, 7 [CR] [LF]
28/07/03,12:11:24, 240.920, 8 [CR] [LF]
28/07/03,12:11:22, 240.937, 9 [CR] [LF]
28/07/03,12:11:20, 240.935, 10 [CR] [LF]
28/07/03,12:11:18, 240.943, 11 [CR] [LF]
28/07/03,12:11:16, 240.935, 12 [CR] [LF]
```

## Command R – Set instrument ID, time and date

This command enables you to set the time, date and two ID strings remotely. This information is displayed on the instrument's status screen.

**CAUTION:** All records stored in the instrument are erased when you use this command.

Transmit the command 'R' and then wait to receive a response 'D' from the instrument before you transmit the data string.

### Example

Transmit R

Wait to receive D

Transmit the data string:

```
CasellaCEL, (01234)844100,K,28/07/03,12:30 [CR] [LF]
```

- The maximum ID string length is 16 bytes.
- The date format is dd/mm/yy.
- The time format is hh:mm using the 24-hour format.

### Command <D(?)> – ‘Online’ mode data set

Response

```
<DATA, 2013-11-27, 15:41:07, INS, XXX.XXX, <10s, XXX.XXX, 01m, XXX.XXX,
05m, XXX.XXX, 15m, XXX.XXX, 60m, XXX.XXX, STE, XXX.XXX, TWA, XXX.XXX,
SPA, XXX.XXX, ZER, XXX.XXX, SP1, XXX.XXX, FAC, nn.nnn> (CRLF)
```

Where:

2013	=Year
11	=Month
27	=Day
15	=Hour
41	=Minutes
07	=Seconds
INS	=Instantaneous reading
10s	=10 Second rolling average
01m	=1 Minute rolling average
05m	=5 Minute rolling average
15m	=15 Minute rolling average
30m	=30 Min rolling average
60m	=1 Hour rolling average
Average	=Average (accumulated average concentration since reset)
SPA	=Current instrument Span value
ZER	=Current instrument Zero offset value
SP1	=Spare for future use
FACT	=User selected dust factor (Number between 0.400 and 10.000)
(CRLF)	=Carriage return line feed

Notes:

The date and time values are generated by the Microdust Pro instrument and represents the time stamp of the following data set.

XXX.XXX = Numeric dust concentration values in mg/m<sup>3</sup>. Variable decimal point position, no leading zeros.

The average value resets at midnight.