

In air ducts and processes

MEASUREMENT OF VOLUME FLOWS

VOLUME FLOW MEASUREMENT

In building and process technology, it is necessary to measure the quantities of air flowing into rooms or processes or being circulated in the plant. The quantity of air transported in a given period of time is known as the volume flow (most common unit: m³ or ft³ per hour). Accuracy down to the last decimal point is not usually critical in these applications. The key features are reliability, robust build quality and good value for money.

The most commonly used method of measuring volume flows is based on the principle of differential pressure. This has a number of specific advantages:

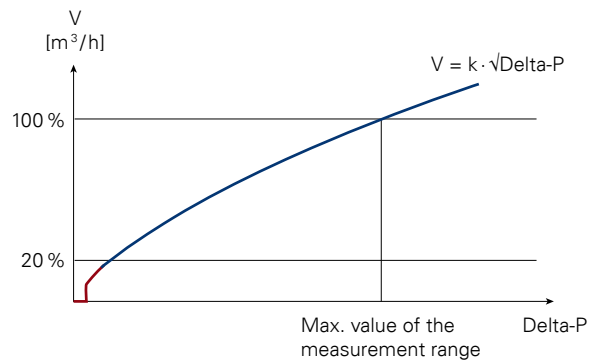

- low investment costs, especially for ducts with medium or large cross-sections
- minimal calibration costs
- process technology: can also be used in plants where temperatures differ significantly from room conditions

Please note that the differential pressure method of measuring volume flow cannot accurately record very small volume flows. These low measurement values are therefore suppressed (*creep suppression*), e.g. the lowest 3 % of the differential pressure measurement range. However, in typical air conditioning and ventilation systems, as well as in most process technology plants, the volume flows lie between 20 and 100 % of the maximum measurement range so this does not result in any significant limitations.



SUITABLE DEVICES

halstrup-walcher offers a choice of high quality differential pressure transmitters with square-root output. All these devices are designed for indoor room conditions as well as for system pressures of up to 6 bar optional (P26). To complete the measurement point, select a primary element (see p. 12) and request an on-site calibration (p. 47).

	P26	P34	P29	P82R / P82RM
Details on	p. 14 (air meter) p. 26	p. 27	p. 28	p. 30
				
Special feature	Scalable, large selection of units	Similar to P26, specifically designed for the control cabinet	Similar to P26, can be used in applications with natural gas	For standard applications, also available with metal housing (optional)
Volume flow	✓	✓	✓	✓
Volume (consumption)	✓ (optional)	-	-	-
Differential pressure	✓	✓	✓	✓
Accuracy	✓ ✓	✓ ✓	✓ ✓	✓
Pressure / temperature compensation	-	✓ (optional: Absolute pressure sensor on board, temperature analogue input)	-	-
20-point curve	-	✓ (can be stored)	-	-

CONVERSION TABLE

	m³/h	m³/min	ft³/h	ft³/min
m³/h	1	0.0167	35.3147	0.5886
m³/min	60	1	2118.8800	35.3147
ft³/h	0.0283	0.0005	1	0.0167
ft³/min	1.6990	0.0283	60	1

Please read the lines from left to right.
Example: 1 m³/h corresponds to 35.3147 ft³/h.

PRIMARY ELEMENTS – MODE OF OPERATION AND SELECTION

In order to convert the volume flow into a differential pressure, so-called primary elements are installed in the air duct or process. This either constricts the cross-section concentrically (orifice plate, cone, venturi).

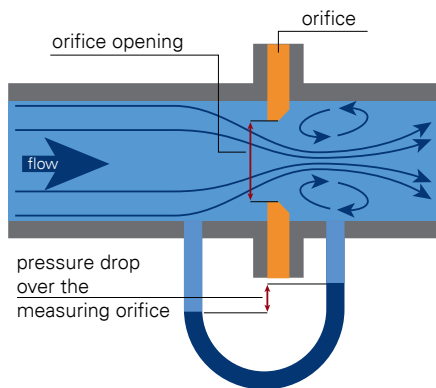

Or the sum of the static and dynamic pressure is measured and recorded (pitot tube, flow tube, Wilson flow grid) at one or several points and the static pressure subtracted. The latter group of primary elements offer the advantage that there is only a minimal loss of pressure – which noticeably reduces operating costs!

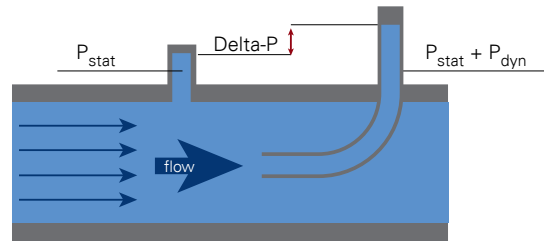

The primary element can be newly designed and supplied by halstrup-walcher. It is also possible to connect the halstrup-walcher pressure transmitter to a primary element that is already installed.

Case 1: Using an primary element that is already installed; supplements a differential pressure transmitter.

The differential pressure transmitter can be combined with any suitable primary element that has already been installed.

- Customer data: max. volume flow [m³/h or ft³/h] and the associated max. differential pressure*
- halstrup-walcher: selection of the differential pressure transmitter measurement range above this max. differential pressure value

Case 2: Complete package of primary element and transmitter from halstrup-walcher

- Customer data: max. volume flow [m³/h or ft³/h] and air duct dimensions (width x height or diameter)*
- halstrup-walcher: Selection of the primary element, calculation of the max. differential pressure, selection of the appropriate measurement range for the differential pressure transmitter

* **Process technology:** Please also state the air temperature and pressure.

Primary element ¹	Image	Order number (length [mm]) ²	Accuracy
Pitot tube / flow tube^{a)}	 The pitot tube measures at a single point (centre of the duct)	Supplied in "L"-form with threaded adjustable collar 9052.0007 (305 mm) 9052.0008 (483 mm) 9052.0009 (795 mm)	✓
(Two) flow probes / X-grid^{b)}	 The 2 flow probes record measurements at several points. Can be installed in parallel or rotated by 90° ("X-grid").	9052.0001 (100 mm) 9052.0002 (150 mm) 9052.0003 (200 mm) 9052.0004 (300 mm) 9052.0005 (400 mm) 9052.0006 (500 mm)	✓ ✓
Wilson flow grid	 The flow grid measures at many positions	9052.0010 (round, D: 100 .. 500 mm) 9052.0011 (round, D: 501 .. 1 000 mm) 9052.0012 (rectangular, W x H of 100 x 150 to 450 x 450 mm)	✓ ✓ ✓

^{a)} The pitot tubes/flow tubes are supplied with a screw clamp.

^{b)} A "set" of flow probes comprises the following parts: 2 flow probes, approx. 2 m tubing, 2 sealing rings (for the probes), operating instructions, 2 elbows (for connecting tubing)

¹ We are also pleased to offer primary elements for process technology or customer-specific applications, see p. 13

² Pitot tube and flow probes: length must be less than the width of the air duct. Flow grid: please state precise dimensions.

Straight inlet (= 10 D) and outlet (= 5 D) pipes are ideal (D = inner diameter)

Recommended for on-site adjustment: Multi-point flow measurements in accordance with DIN EN 12599 (average value calculated from multiple measurement points per m² of cross-sectional area). Please enquire about our range of services (see p. 47). You can find further accessories on p. 21.

DELIVERY OF COMPLETELY CALIBRATED VOLUME FLOW MEASURING SECTIONS

Measuring facilities that deliver a precise volume flow value are needed in machine and plant construction, as well as in climate technology. On-site calibration is often not economically efficient. For these applications, halstrup-walcher offers complete solutions that include the pipe/air channel section (with a diameter of 25..700 mm) as well as the installed primary element and measuring transmitter, if required incl. tubing and control cabinet. Multi-point calibration at our volume flow calibration stand completes this overall solution.



VOLUME FLOW MEASUREMENT IN PROCESSES

Accurate measurement of volume flow in air ducts or ventilation systems (e.g. in m^3/h or ft^3/h) is becoming increasingly important. This is because volume flow is an important process technology parameter, e.g. for ensuring a specific drying quality or the ability of a test facility to function correctly. But it is also essential to monitor minimum volume flows in critical air-conditioning systems, such as those used for cleanrooms.

Your volume flow partner, halstrup walcher

- provides support in designing measurement points and primary elements (incl. optional temperature sensors)
- takes responsibility for installation on-site
- calibrates and adjusts equipment on-site

This ensures that all the installation conditions (and resulting asymmetries of the flow profile) are taken into account to produce the optimum result.

For process technology, halstrup-walcher supplies process probes with optimised geometries (see photo). As you can see from the flow simulation, these prevent the generation of vortices, which are created by standard flow pressure probes. Higher accuracy and lower sensitivity to shorter inlet routes are the results.

The following design parameters must be stated: medium (air or non-aggressive gases), temperature (special versions for use at temperatures $> 400^\circ\text{C}$ are possible), static pressure (up to 6 bar), design volume flow (e.g. $5000 \text{ m}^3/\text{h}$), air duct dimensions or installation dimensions as well as the ambient conditions (indoor, non-Ex, ...).

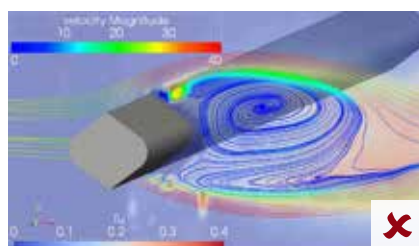
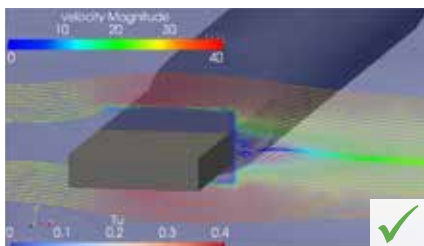

P 26 AIR METER/MEASUREMENT OF AIR CONSUMPTION



APPLICATION

Today, it is very rare to measure air consumption for individual users. Costs are usually apportioned based on the total costs and the respective share of the total area occupied. For example, a tenant renting 23 % of the total area will always pay 23 % of the air-conditioning costs. This is unfair in terms of user behaviour and different air conditioning requirements for different room types – and importantly it offers no incentive to find savings. However, particularly in commercial properties which are rented out to a number of tenants, air consumption is seen as being identical to other consumed media (electricity, water, etc.) and there are demands for these costs to be apportioned fairly in the same way, i.e. based on actual consumption. The same applies equally to industrial companies with an energy management system.

The P 26 air meter takes the following approach: based on the volume flow measurement using the principle of differential pressure (please select a suitable primary element, see p. 12), the P 26 air meter adds up and displays the volumes consumed (m^3 or ft^3 of air) and makes the data available via a pulse output (optionally also via M-bus).

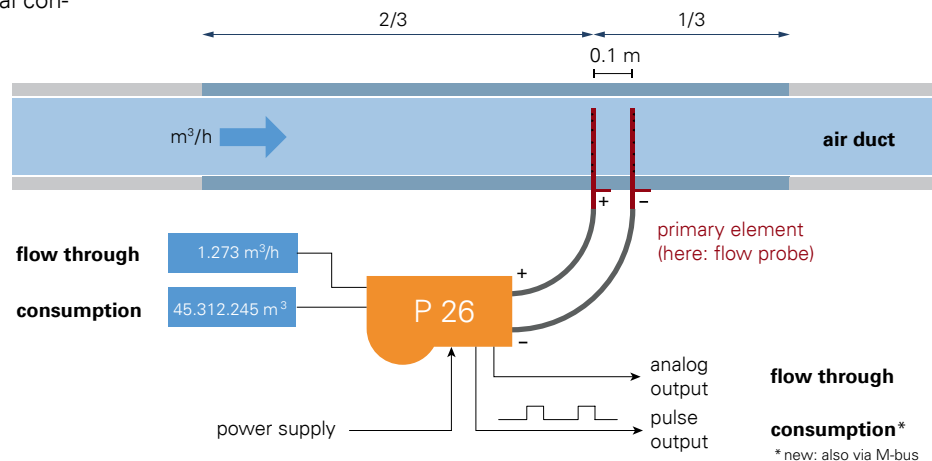

FEATURES

- legally secure through traceable on-site calibration
- security: code-protected function, no unauthorised operation
- the total volume consumed (and an operating hour counter) can be reset after entering a code either to zero or to a "total before reset" saved as a backup
- the pulse valency (m^3 or ft^3 per pulse), pulse length and pulse interval can be set individually
- an internal operating hour meter provides a time reference – operational security without batteries.

You can find technical data and ordering information on p. 15.

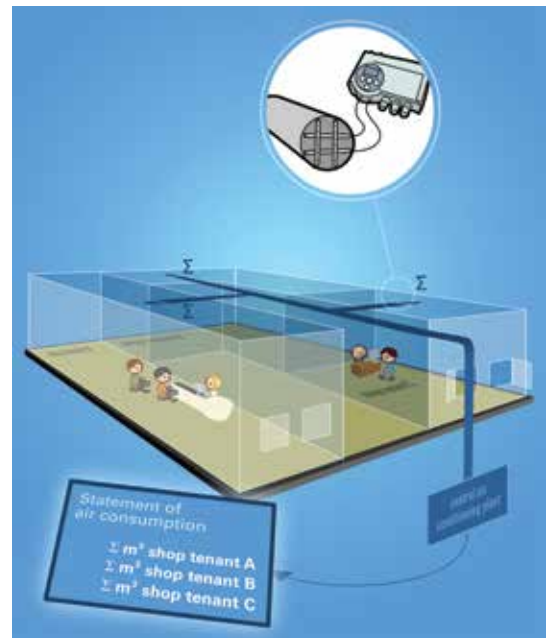

Air meter in shopping centre: metered consumption replaces apportionment of costs per m^2

ORDERING OPTIONS FOR P26 AIR METER

Order code	A	B	C	D	E	F	G
P26	-	-	-	-	-	-	-

Analog output	A
0..20 mA	0
0..10 V	1
4..20 mA	4

Measurement range	C
Selected by halstrup-walcher based on your design data	-

Display, keyboard	E
without	0
multi-coloured LCD ^{a)}	LC

The meter is configured either using the display (E = LC), the device's internal RS232 interface or the external USB port (G = US).

^{a)} recommended for air meter

Power supply	B
24 VAC/DC	24ACDC
24 VAC	24AC
230/115 VAC	230/115

Degree of measurement uncertainty	D
$\pm 0.2\%$ ^{b)}	2
$\pm 0.5\%$ ^{b)}	S

Switch output + pulse output	F
1 x relay (switch output) max. 230 VAC, 6 A and 1x pulse output (air meter)	1

Digital interface ^{c)}	G
without	0
USB, incl. cable	US

^{c)} Please enquire about communication via M-bus.

^{b)} of the scaled range
(40..100 % of max. value)
(min. 0.3 Pa)

LEGALLY SECURE ON-SITE CALIBRATION



After the primary element and P26 differential pressure transmitter have been mounted, the latter is parameterised and adjusted on the basis of an on-site calibration. This is legally secure and traceable to national standards. Adjustments are made either via a user-friendly operating menu or using simple PC parameterisation software. This software is available to download from our website. halstrup-walcher is

also pleased to offer services for complete on-site commissioning of the air meter measurement point; see also p. 47.

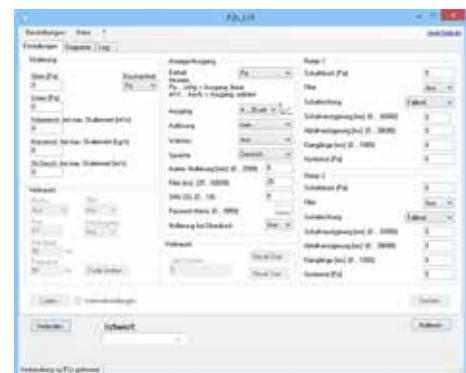

P26 air meter parameterisation software

TECHNICAL DATA FOR P26 AIR METER

Units	m ³ /h, m ³ , ft ³ /h, ft ³ , kg/h, kg	Overload resistance	200x, max. 6 bar
Sampling rate	1x per second	Operating temperature	10..50 °C
Saves sum value, sum before reset, operating hour counter	every 10 min and when device powers down	Storage temperature	-10..70 °C
Max. no. of values without sum reset	> 2 billion measured values [m ³ , ft ³ , kg]	Power consumption	approx. 6 VA
Max. period of time without sum reset	199999 hours or > 20 years	Weight	approx. 0.75 kg (P26 without primary element)
Value per pulse (meter output)	0.1..10000 m ³ 3.6..350000 ft ³ (freely selectable) 0.1..10000 kg	Meter modes (adjustable)	<ul style="list-style-type: none"> • Only positive volume flows VF • Balance of positive and negative VF • Total sum of positive and neg. VF
Pulse length	20..2000 ms	Pressure ports	for tubing NW 6 mm
Pulse interval	50..2000 ms	Protection class	IP 65, with USB IP 40
Measuring accuracy	with measurement probes approx. $\pm 4\%$ (in straight measurement sections)	Time constant	25 ms..60 s (adjustable)
Medium	Air, non-aggressive gases	Cable gland	3 x M 16
Certificates	CE, CSA	Dimension drawing	see P26 on p. 26

Measurement ranges (also ± measurement ranges) others available upon request	10/50/100/250/500 Pa 1/2.5/5/10/20/50/100 kPa freely scalable from 10..100 % within a measurement range
Margin of error (0.3 Pa margin of error for reference)	± 0.2 % or ± 0.5 % of the scaled range (40..100 % of max. value) (min. 0.3 Pa)
Temperature coefficient span	0.03 % of max. value/K (10..50 °C)
Temperature coefficient zero point	± 0 % (cyclical zero-point correction)
Max. system pressure/ Overload capacity	600 kPa for measurement ranges ≥ 2.5 kPa 200 x for measurement ranges < 2.5 kPa
Medium	Air, all non-aggressive gases
Sensor response time	25 ms
Time constants	25 ms..40 s (adjustable)
Operating temperature	10..50 °C
Storage temperature	-10..70 °C
Power consumption	approx. 6 VA
Weight	approx. 750 g
Cable glands	3 x M16
Pressure ports	for tubing NW 6 mm, others available on request
Protection class	IP65, with USB: IP40
Certificates	CE, CSA

Output (linear/ root-extracted) ¹⁾	A
0..10 V (R _L ≥ 2 kΩ)	1
0..20 mA (R _L ≤ 500 Ω)	0
4..20 mA (R _L ≤ 500 Ω)	4
± 5 V (R _L ≥ 2 kΩ)	5

¹⁾ output signals can be configured freely

Power supply	B
24 VAC/DC	24ACDC
24 VAC (with galvanic separation)	24AC
230/115 VAC	230/115

Measurement range	C
Measurement range e.g. 0..10 Pa, -10..50 mbar, ± 100 mmHg (etc.)	

Margin of error	D
± 0.2 % ²⁾	2
± 0.5 % ²⁾	S

²⁾ of the scaled range (40..100 % of max. value) (min. 0.3 Pa)

Display, Keyboard	E
none	0
multi-coloured LCD and keyboard	LC



Contact points	F
none	0
Air meter (see p. 14)	1
2 relays (changeover contacts) max. 230 VAC, 6 A	2

Data interface	G
none	0
USB (data cable supplied)	U0
External zero-point calibration	0X
External zero-point calibration and USB (data cable supplied)	UX

Order code	A	B	C	D	E	F	G
P 26	-	-	-	-	-	-	-

Can be pre-set on request:
Time constant, relay parameter, analogue output root-extracted / linear, deactivation of the cyclic zeroing



Features

- High precision differential pressure transmitter for top-hat rail or wall mounting (air-conditioning, cleanroom, process)
- Wide range of units available for pressure and volume flow, also ± measurement ranges
- Scalable measurement ranges and units
- Zero-point calibration prevents zero-point drift
- Built-in valve provides a high level of overpressure protection
- Multilingual menu (German/English/Italian/French)

Optional

- Contact points with adjustable switching outputs
- Set the zero-point via the interface
- USB interface (free parameterisation software at www.halstrup-walcher.com)
- Air meter function (see p. 14)

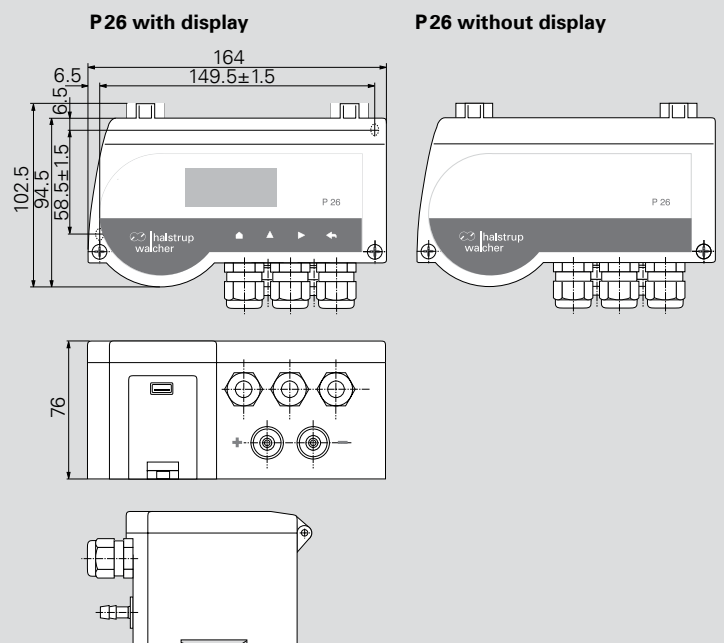



Features

- Differential pressure transmitter with very small dimensions – ideal for control cabinet installation
- Optionally with temperature analogue input and internal stat. pressure sensor for P-/T-compensated volume flow
- Optionally with relay
- Volume flow can be configured via k-factor, dPmax/Vmax or 20 individual values
- With USB interface: via PC-software (password-protected), scaling, characteristic line form and many other parameters can be set
- Delivery possible already completely integrated into the control cabinet (on request)



Easy Mounting:

The differential pressure transmitter P34 is particularly developed for space-saving mounting in control cabinets.

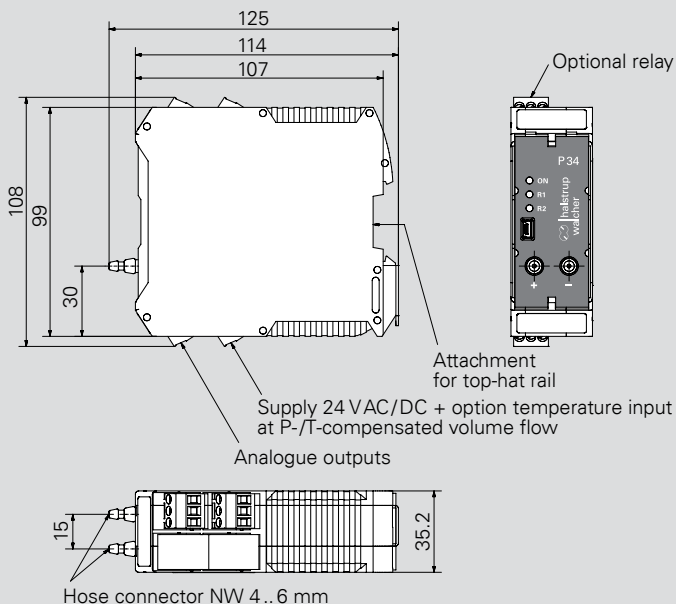

Measured data differential pressure

Measurement ranges (also ± measurement ranges) others available upon request	10/50/100/250/500 Pa 1/2.5/5/10/20/50/100 kPa freely scalable from 10..100 % within a measurement range
Margin of error (0.3 Pa margin of error for reference)	±0.2 % or ±0.5 % of the scaled range (40..100 % of max. value) (min. 0.3 Pa)
Temperature coefficient span	0.03 % v. E./K (10..50 °C)
Temperature coefficient zero point	±0 % (cyclical zero-point correction)
Max. system pressure/ Overload capacity	400 kPa measurement ranges ≥ 2.5 kPa 200 x measurement ranges < 2.5 kPa
Medium	Air, all non-aggressive gases
Sensor response time	25 ms
Time constants	25 ms..60 s (adjustable)
Operating temperature	10..50 °C
Storage temperature	-10..70 °C
Power consumption	approx. 6 VA
Weight	approx. 450 g
Connections	Screw terminals (connection capacity 0.25..2.5 mm ²)
USB interface	USB 2.0 Full-Speed Slave (Mini USB)
Pressure ports	for tubing NW 4..6 mm
Protection class	IP20
Certificates	CE

Measured data for P-/T-compensated volume flow (optional)

Measured range absolute pressure	200 kPa
Accuracy absolute pressure	±2.0 % of max. value
Temperature input	4..20 mA, R _i = 130 Ω Temperature range freely scalable

Power supply

24 VAC/DC ± 10 %

Output (linear / root extracted)	A
0..10 V (R _L ≥ 2 kΩ)	1
0..20 mA (R _L ≤ 500 Ω)	2
4..20 mA (R _L ≤ 500 Ω)	3

Measurement range	B
Measurement range e.g. 0..10 Pa, -10..50 mbar, ±100 mmHg (etc.)	

Margin of error	C
± 0.2 % ²⁾	2
± 0.5 % ²⁾	5

Contact points	D
none	0
2 relays (changeover contacts) max. 230 VAC, 6 A	2

²⁾ of the scaled range (40..100 % of max. value) (min. 0.3 Pa)

Application	E
Standard	A
P-/T-compensated volume flow	B

Order code	A	B	C	D	E
P34	-	-	-	-	-

Can be pre-set on request:

Time constant, relay parameter, analogue output root-extracted / linear, deactivation of the cyclic zeroing

Measurement ranges others available upon request	250/500 Pa 1/2.5/5/10/20/50/100 kPa freely scalable from 10..100 % within a measurement range
Margin of error	±0.2 % of max. value or ±0.5 % of max. value
Temperature coefficient span	0.03 % of max. value/K (10..50 °C)
Temperature coefficient zero point	±0 % (cyclical zero-point correction)
Overload capacity	100 kPa for measurement ranges ≥ 2.5 kPa 200 x for measurement ranges < 2.5 kPa
Medium	Natural gas
Max. system pressure	100 kPa for all measurement ranges
Sensor response time	25 ms
Time constants	25 ms..60 s (adjustable)
Operating temperature	10..50 °C
Storage temperature	-10..70 °C
Power consumption	approx. 6 VA
Weight	approx. 750 g
Cable glands	2 x M 16
Pressure ports	2 x laboratory nozzle DIN 12898
Protection class	IP 65
Certificates	CE, EN1127-1:2007

Output (linear/ root-extracted) ¹⁾	A
0..10 V ($R_L \geq 2 \text{ k}\Omega$)	1
0..20mA ($R_L \leq 500 \Omega$)	0
4..20mA ($R_L \leq 500 \Omega$)	4
±5 V ($R_L \geq 2 \text{ k}\Omega$)	5

Power supply	B
24 VDC	24 DC

¹⁾ output signals can be configured freely

Measurement range	C
Measurement range e.g. 0..250 Pa, -10..50 mbar, 0..100 mmHg (etc.)	

Margin of error	D
±0.2 % of max. value	2
±0.5 % of max. value	S

Display, keyboard	E
none	0
multi-coloured LCD and keyboard	LC



Tubing connections	F
Standard for tubing NW 5-8 mm	0
Cutting ring coupling 8 mm	S

Order code	A	B	C	D	E	F
P 29						

Can be pre-set on request:
Time constant, relay parameter, analogue output root-extracted / linear, deactivation of the cyclic zeroing

TÜV-tested:

As long as a specified flushing process is observed, special electronic encapsulation safely separates any ignition sources from natural gas.



Features

- TÜV-tested differential pressure transmitter for natural gas
- Design changes and technical modifications keep ignition source and gas mixture safely separated (not suitable for Ex-applications)
- Also ± measurement ranges
- Scalable measurement range and display
- For pressure and volume flow measurement
- Zero-point calibration prevents zero-point drift
- Built-in valve provides a high level of overload protection
- Also suitable for top-hat rail mounting
- Multilingual menu (German/English/Italian/French)

P 29 with display

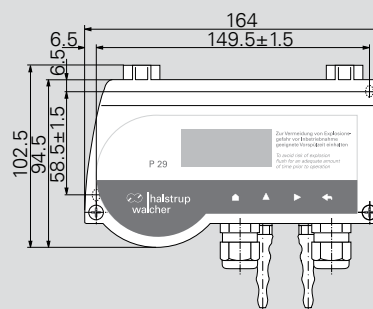

P 29 without display

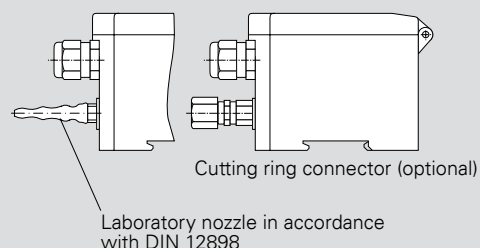
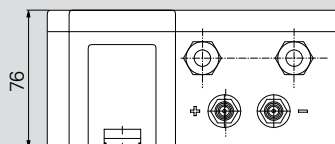
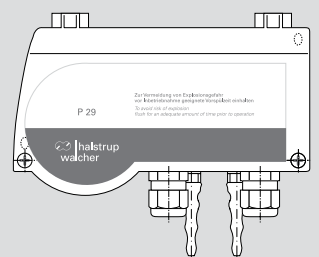

halstrup-walcher GmbH
Stegener Str. 10
79199 Kirchzarten
Germany

Tel. + 49 (0) 76 61 39 63-0
Fax + 49 (0) 76 61 39 63-99
www.halstrup-walcher.com
info@halstrup-walcher.de



Australia / New Zealand

Bestech Australia Pty, Ltd.
Unit 14, 44 Garden Blvd,
Dingley, VIC 3172
Australia
Tel. +61 (0) 3 9540 5100
Fax +61 (0) 3 9551 5541
Enquiry@bestech.com.au
www.bestech.com.au

Belgium / Luxembourg / Netherlands

DIMED nv
Joe Englishstraat 47
2140 Antwerpen
Belgium
Tel. +32 3 236 64 65
Fax +32 3 236 64 62
info@dimed.be
www.dimed.eu

China

Shanghai Yu Ting
Scientific Co., LTD
BeiGuan Village, MaLu Town,
JiaDing District,
Shanghai City, PRC
Tel. +86 21 6915 3366
Tel. +86 21 6915 5916
Fax +86 21 6915 3939
ch-sys@ch-sys.net
www.ch-sys.com

Denmark

Hans Buch A/S
Roskildevej 8-10
2620 Albertslund
Tel. +45 43 68 50 00
Fax: +45 43 68 50 50
info@hansbuch.dk
www.hansbuch.dk

Italy

FISME srl
Via Volta 21
20082 Binasco (MI)
Tel. +39 02 905 53 58
Fax +39 02 905 22 67
fisme@tin.it
www.fisme.it

Japan

Krone Corporation
2-22-1 Higashi-Shinkoiwa
Katsushika-ku
J-Tokyo 1240023
Tel. +81 (0) 3 3695 5431
Fax: +81 (0) 3 3695 5698
sales-tokyo@krone.co.jp
www.krone.co.jp

Austria / Croatia / Serbia / Hungary / Slovenia

Industrie Automation Graz
Ing. W. Häusler GmbH
Autaler Str. 55
8074 Raaba
Austria
Tel. +43 (0) 316 405 105
Fax +43 (0) 316 405 105-22
office@iag.co.at
www.iag.co.at

Sweden

DJ Stork Automation AB
Karlsbodavägen 39
168 67 Bromma
Tel. +46 (0) 8 635 60 30
Fax +46 (0) 8 635 60 31
stork@storkautomation.se
www.storkautomation.se

Switzerland

Swissfilter AG
Gewerbestrasse 3
5037 Muhen
Tel. +41 (0) 62 737 54 80
Fax +41 (0) 62 737 54 81
info@swissfilter.ch
www.swissfilter.ch

Turkey

CAGDAS Automation
& Engineering Co. Ltd.
Kizilay cad. 28006 sok No: 5
01010 Seyhan / Adana
Tel. +90 322 359 81 85
Fax +90 322 359 36 39
cagdas@cagdasltd.com.tr
www.cagdasltd.com.tr

Taiwan (R.O.C.)

Chih Horng Scientific Co., Ltd.
6F, No.69-5, Sec. 2,
Zhongzheng E. Rd.,
Tamsui Dist.,
New Taipei City 251
Tel. +886 (02) 2808 0169
Fax +886 (02) 2808 0176
chih.mail@msa.hinet.net
www.ch-sys.com

USA

Intelligent Measurement Solutions LLC
7801 Clinton-Macon Road
49236 Clinton, MI
Tel. +1 (616) 608 7919
Tel. +1 (734) 637-1596
Fax +1 (616) 608 7954
darrell@i-m-solutions.net
www.h-wusa.com